



CARDIO DIO

VASCULAR

SUMÁRIO

| | |
|------------------------------------|----|
| Cooley Atrial | 4 |
| Dinkhuysen | 5 |
| Kirklin | 5 |
| Ankeney | 6 |
| Burford | 7 |
| Davidson | 7 |
| Finochietto | 8 |
| Allison Lung | 9 |
| Harrington | 9 |
| De Bakey | 10 |
| Diethrich | 11 |
| Castañeda | 12 |
| Castañeda S | 13 |
| Cooley | 14 |
| De Bakey | 15 |
| De Bakey Potts | 22 |
| De Bakey-Beck | 23 |
| De Bakey-Glover | 24 |
| Derra | 25 |
| Lambert-Kay | 26 |
| Leland-Jones | 26 |
| Ordenha | 27 |
| Saca Cálculo | 28 |
| Pinça para Válvula Mitral | 29 |
| Satinsky | 30 |
| Lahey | 31 |
| Lower | 31 |
| Semb | 31 |
| Carótida | 32 |
| Denis | 33 |
| Dietrich | 33 |
| Dinkhuysen | 33 |
| Punch Aórtico | 34 |
| Boyd | 35 |
| Dietrich | 37 |
| Potts de Martel | 40 |
| Metzenbaum Córdio | 41 |
| De Bakey | 42 |
| Porta agulhas para Coronária | 43 |
| Conjunto Flebo Extrator | 44 |

Cooley Atrial

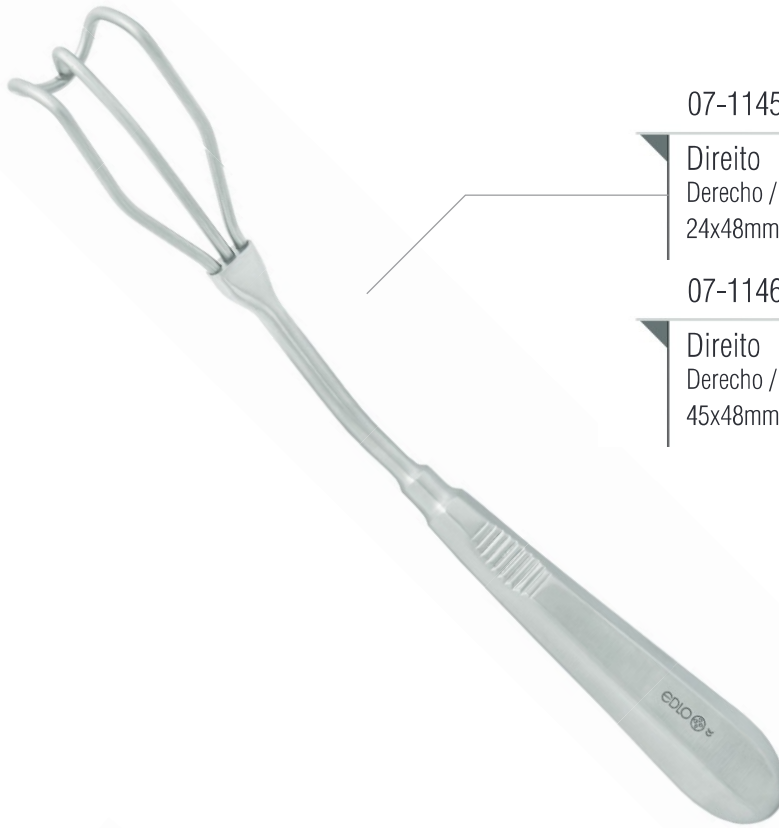

07-1145

Direito
Derecho / Right
24x48mm 21,5cm | 8 1/2"

07-1146

Direito
Derecho / Right
45x48mm 21,5cm | 8 1/2"

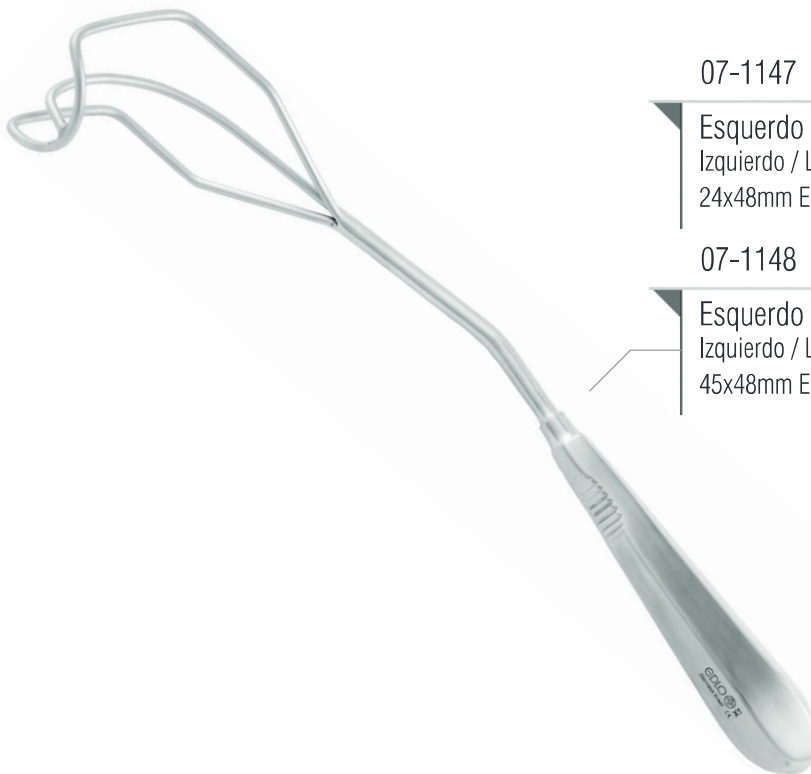

07-1147

Esquerdo
Izquierdo / Left
24x48mm Esquerdo 21,5cm | 8 1/2"

07-1148

Esquerdo
Izquierdo / Left
45x48mm Esquerdo 21,5cm | 8 1/2"

Dinkhuysen

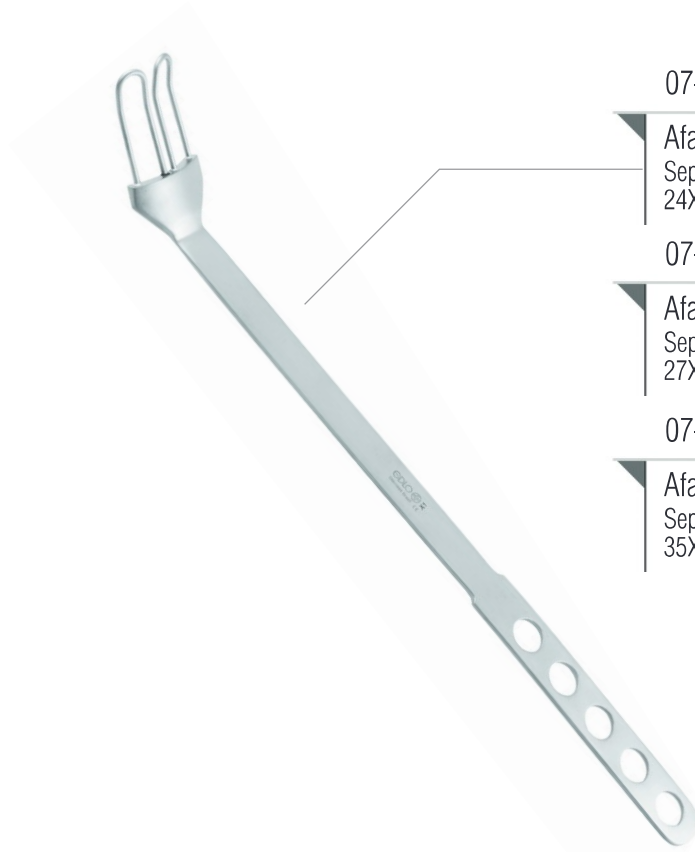

07-2898

Afastador Aorta
Separador de Aorta / Aorta Retractor
24X20mm

07-2899

Afastador Aorta
Separador de Aorta / Aorta Retractor
27X22mm

07-2900

Afastador Aorta
Separador de Aorta / Aorta Retractor
35X25mm

Kirklin



07-1138

10mm 18cm | 7"

07-1139

15mm 18cm | 7"



07-2896

5mm 18cm | 7"



07-2897

7mm 18cm | 7"

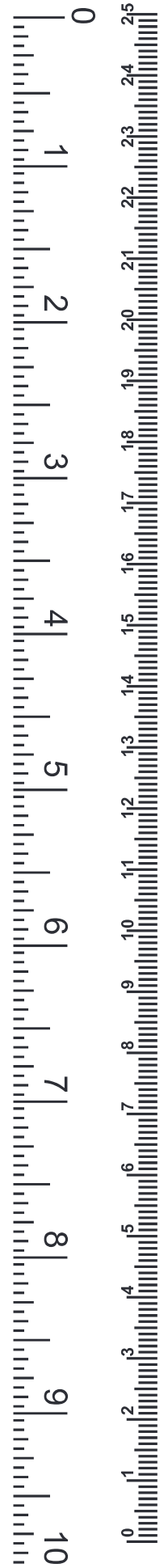

Ankeney

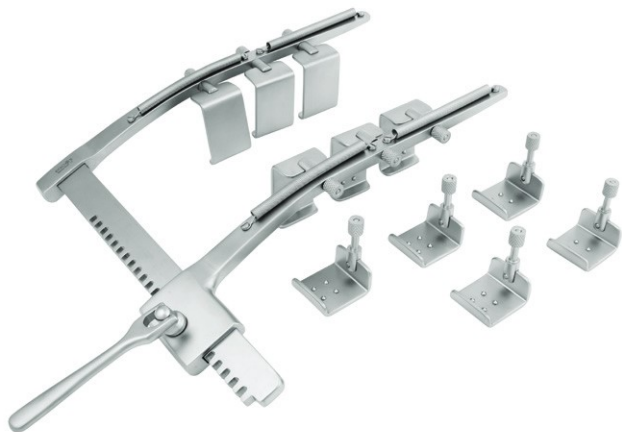

01-0801

Grande
Grande / Large

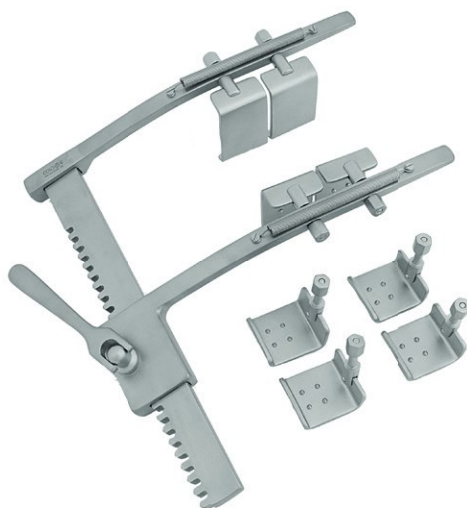

01-0901

Médio
Medium / Medio



01-2506

Infantil
Niño / Small

Burford

01-0786

Válvulas:

Pequena Reta 63x61mm

Grande Reta 73x61mm

Pequena Curva 51x61mm (Intercambiáveis)

Lâminas:

Pequena Recta 63x61mm

Grande Recta 73x61mm

Pequena Curva 51x61mm (Intercambiável)

Blades:

Small Straight 63x61mm

Big Straight 73x61mm

Small Curved 51x61 (Interchangeable)

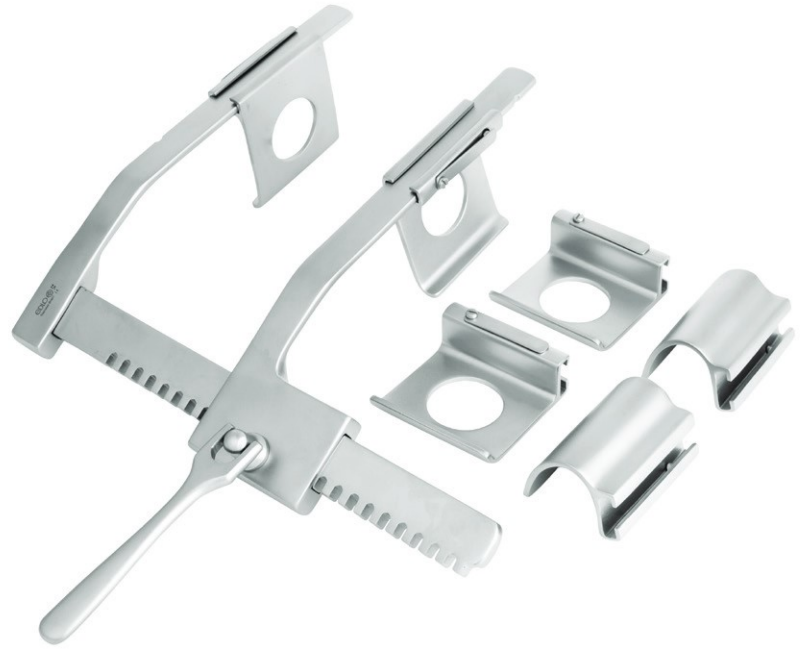

AFASTADORES DE TÓRAX

Separadores / Scapula Retractors

Davidson

01-2776

75X50mm 16cm | 6 1/4" (escápula)

01-2777

75X90mm 16cm | 6 1/4" (escápula)



Finochietto

01-0023

Baby
Bebé / Baby
16X18X72X70mm

01-0024

Infantil
Niño / Small
35X45X130X170mm

01-0025

Médio
Medio / Medium
47X54X165X188mm

01-0026

Adulto
Adulto / Adult
47X54X170X220mm

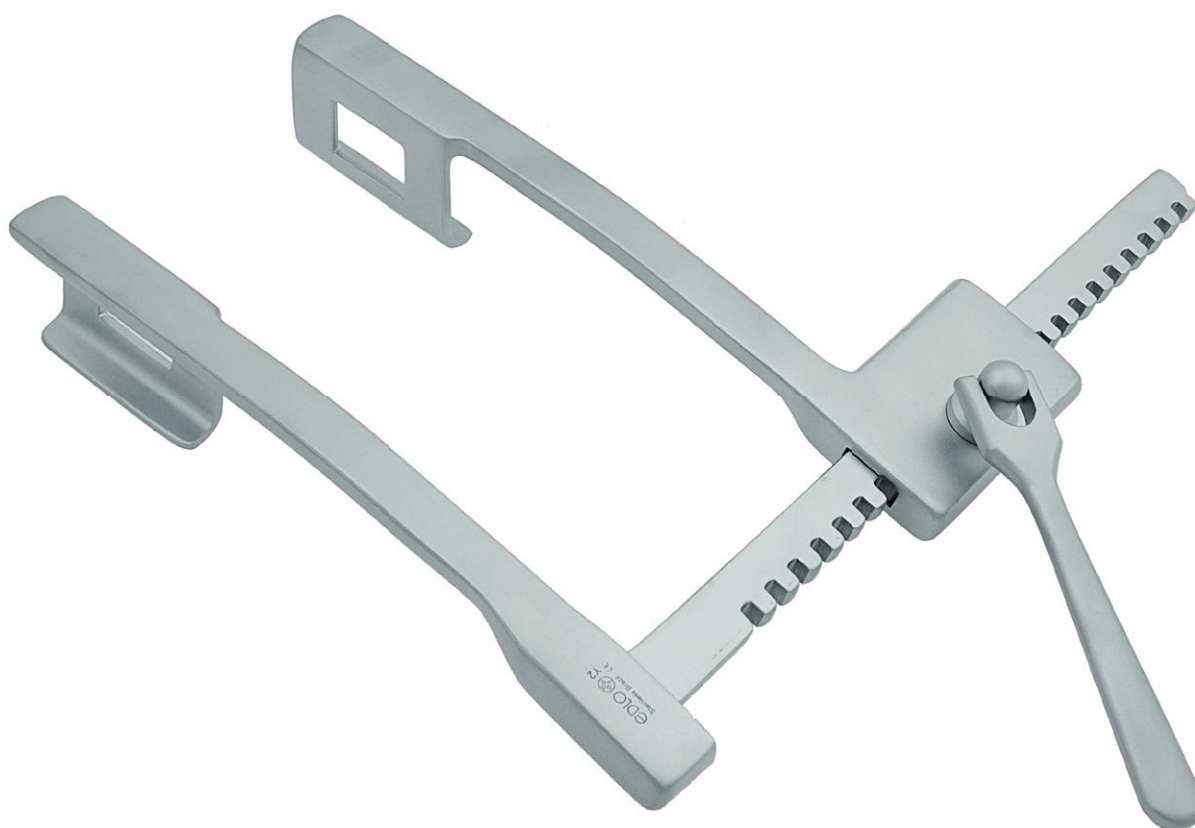

Allison Lung

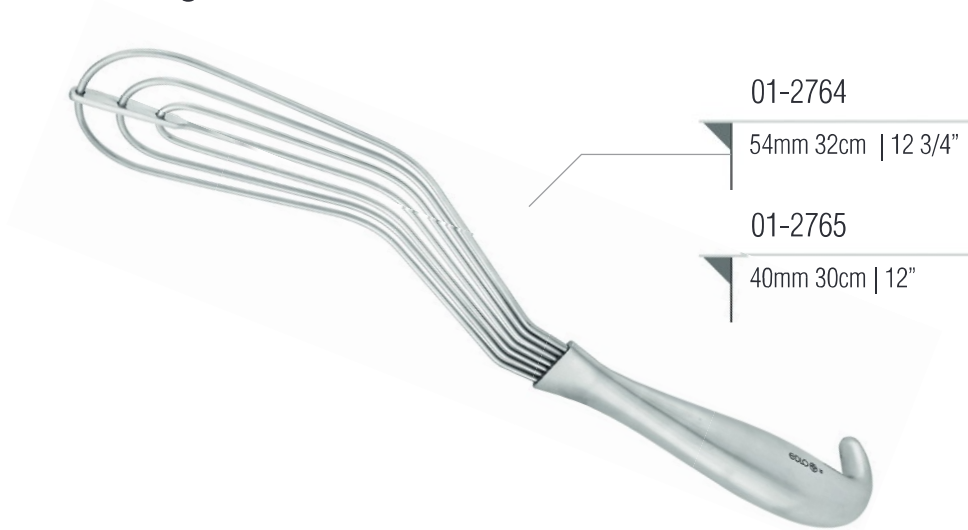

Harrington



De Bakey

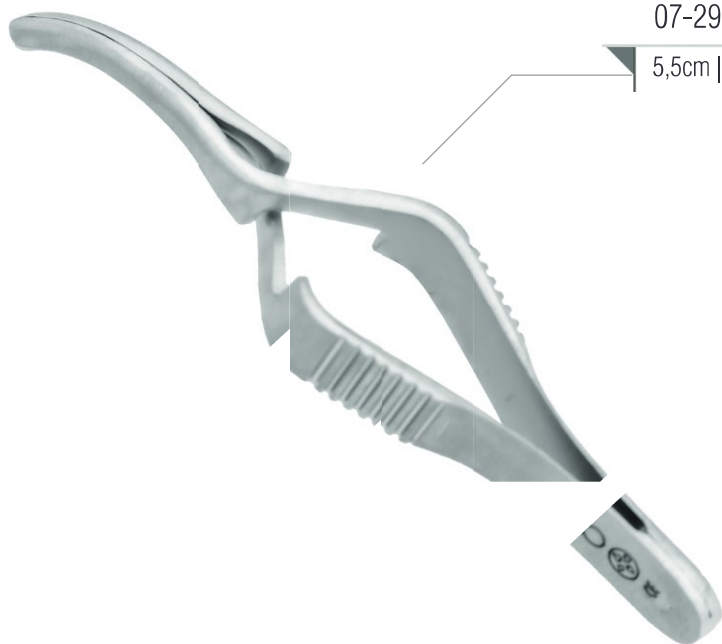

Curva
Curvo / Curved

07-2990

5,5cm | 2 1/4"

07-0553

8,5cm | 3 1/2"



07-0716

9,5cm | 3 3/4"



07-0717

10,5cm | 4 1/4"



07-0718

11,5cm | 4 1/2"

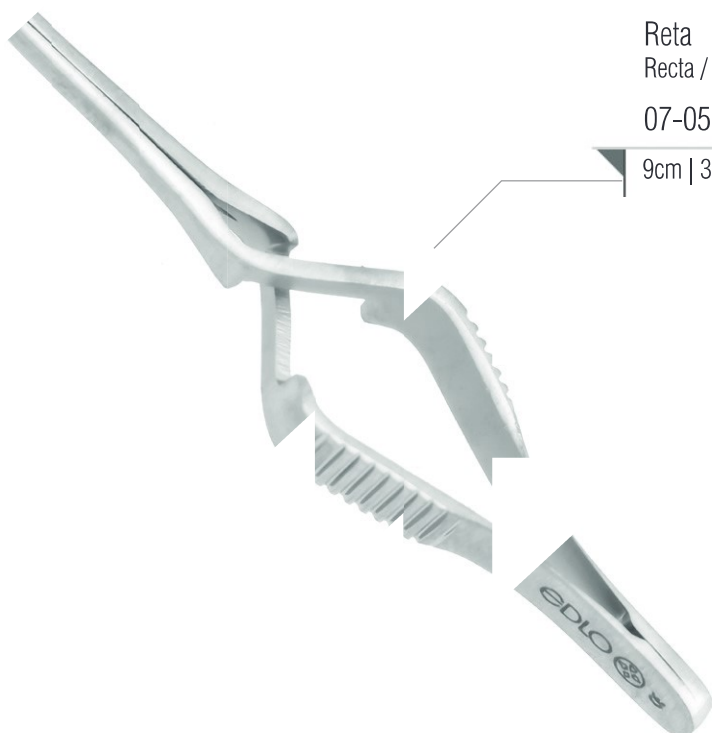

Reta
Recta / Straight

07-0552

9cm | 3 1/2"

07-0713

10cm | 4"



07-0714

11cm | 4 1/4"

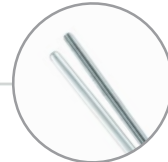

07-0715

12cm | 4 3/4"

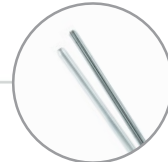

07-2991

5,5cm | 2 1/4"



Diethrich



Curva
Curvo / Curved

07-0795

6cm | 2 1/2"

07-0796

5,5cm | 2 1/4"

07-0797

5cm | 2"



Reta
Recta / Straight

07-0792

6,5cm | 2 9/16"

07-0793

6cm | 2 1/2"

07-0794

5,5cm | 2 1/4"



Castañeda



07-3023

48mm 30° 13cm | 5"



07-3024

48mm 45° 13cm | 5"



07-3025

48mm 90° 11cm | 4 1/4"

07-3026

Reta

Recta / Straight
48mm 13cm | 5"

Castañeda S

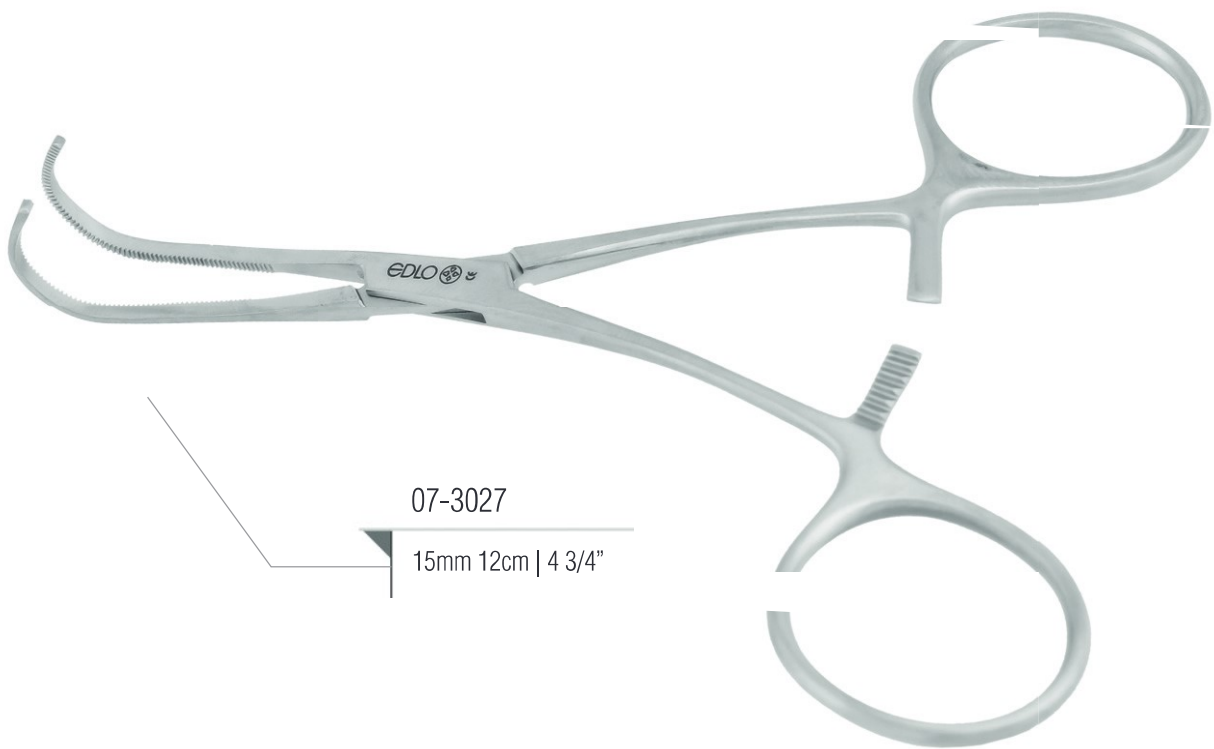

07-3027

15mm 12cm | 4 3/4"

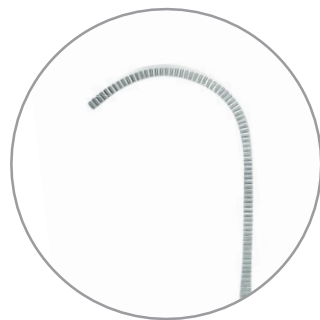

07-3028

18mm 12cm | 4 3/4"

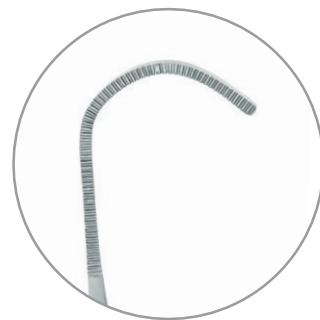

07-3029

23mm 12cm | 4 3/4"

07-3030

25mm 17cm | 6 3/4"

Cooley

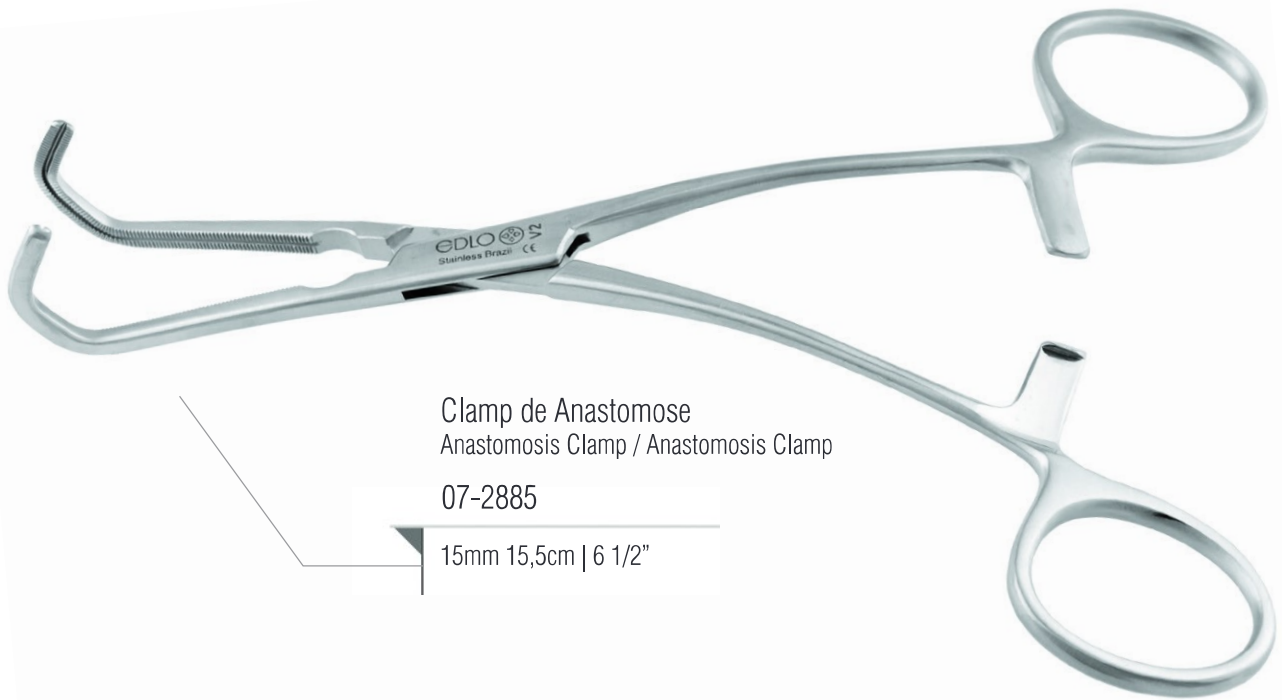

Clamp de Anastomose
Anastomosis Clamp / Anastomosis Clamp

07-2885

15mm 15,5cm | 6 1/2"



07-2886

20mm 15cm | 6"



07-2887

25mm 16cm | 6 1/4"

De Bakey



07-0541

Angulada
Angular / Angled
75mm 60° 18cm | 7"

07-3033

Angulada
Angular / Angled
90mm 60° 20cm | 8"

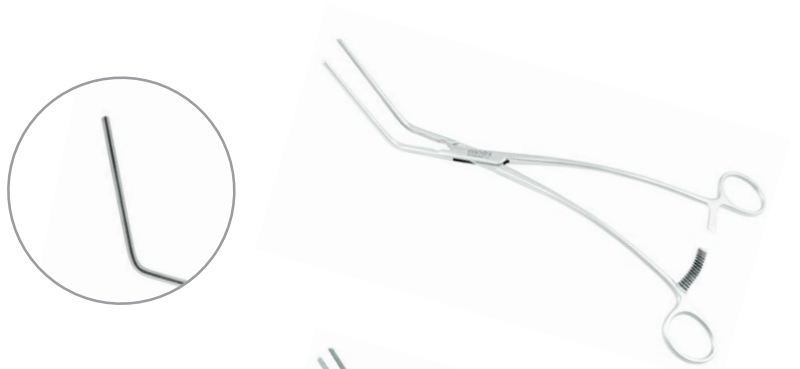

07-0549

Angulada
Angular / Angled
90mm 60° 28cm Aorta



07-2958

Angulada
Angular / Angled
90mm 60° 32cm | 12 1/2"



07-1335

Angulada
Angular / Angled
40mm 45° 13cm | 5"

07-3034

Angulada
Angular / Angled
40mm 90° 12cm | 4 3/4"

De Bakey



07-0542

Coarctação Reta
Coartación Clamp Recta
Coarctation Clamp Straight
55mm 21cm | 8 1/2"



07-0544

Coarctação Reta
Coartación Clamp Recta
Coarctation Clamp Straight
75mm 22cm | 8 3/4"

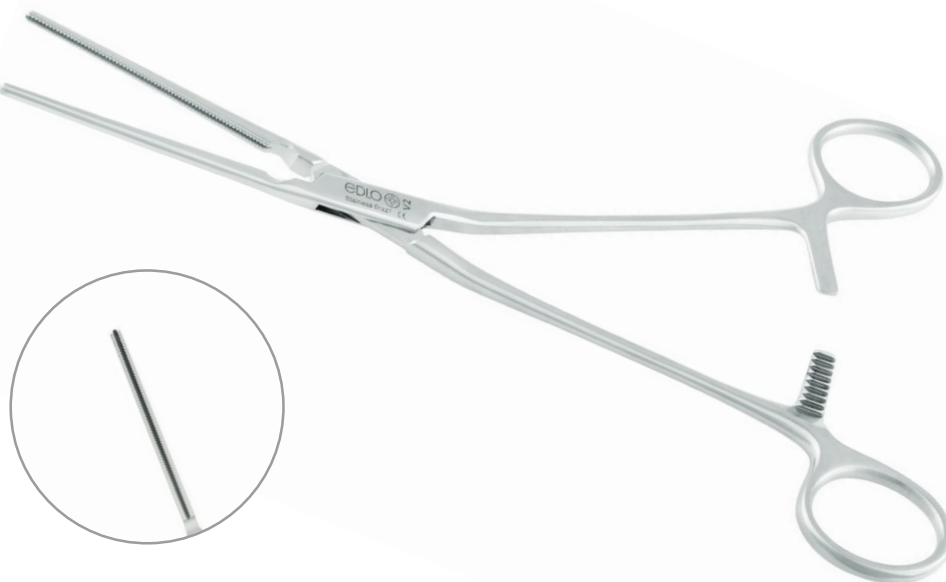

07-0543

Coarctação Angulada no Cabo
Coartación Clamp Mango Angular
Coarctation Clamp Angled Handle
75mm 22cm | 8 3/4"

07-3035

Coarctação Angulada no Cabo
Coartación Clamp Mango Angular
Coarctation Clamp Angled Handle
75mm 24cm | 9 1/2"

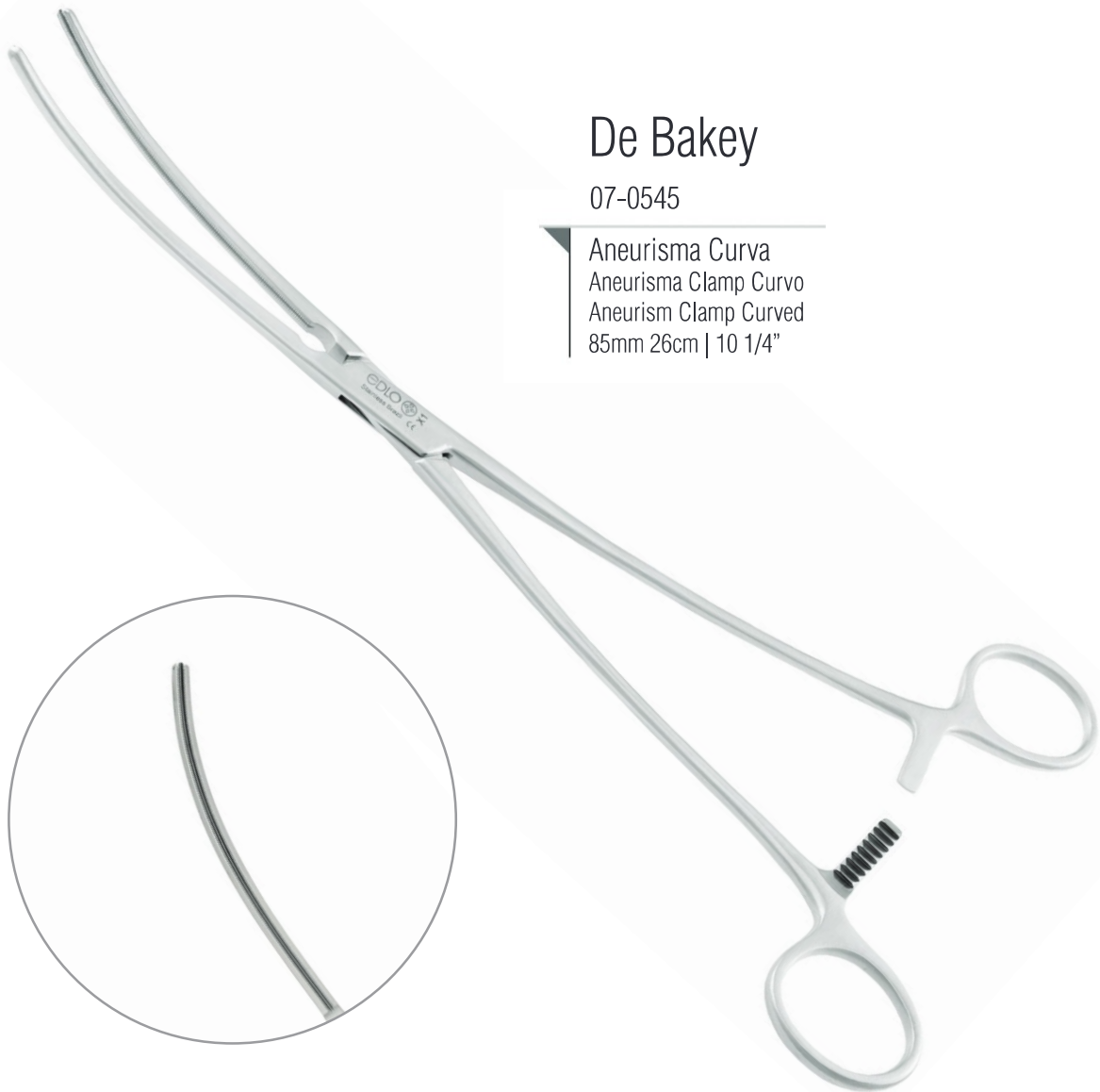

De Bakey

07-0545

Aneurisma Curva
Aneurisma Clamp Curvo
Aneurism Clamp Curved
85mm 26cm | 10 1/4"

De Bakey



07-0555

Curvo
Curvo / Curved
45mm 12,5cm | 5"



07-0703

Curvo
Curvo / Curved
45mm 12,5cm | 5"



07-0551

Curvo
Curvo / Curved
55mm 17cm | 6 3/4"

07-3039

Curvo
Curvo / Curved
60mm 16cm | 6 1/4"

De Bakey



07-0723

Curvo
Curvo / Curved
60mm 18cm 7"

07-3031

Curvo
Curvo / Curved
65mm 18cm | 7"

07-3040

Curvo
Curvo / Curved
60mm 20cm | 8"



07-0546

Curvo
Curvo / Curved
70mm Curva 26cm | 10 1/4"

De Bakey

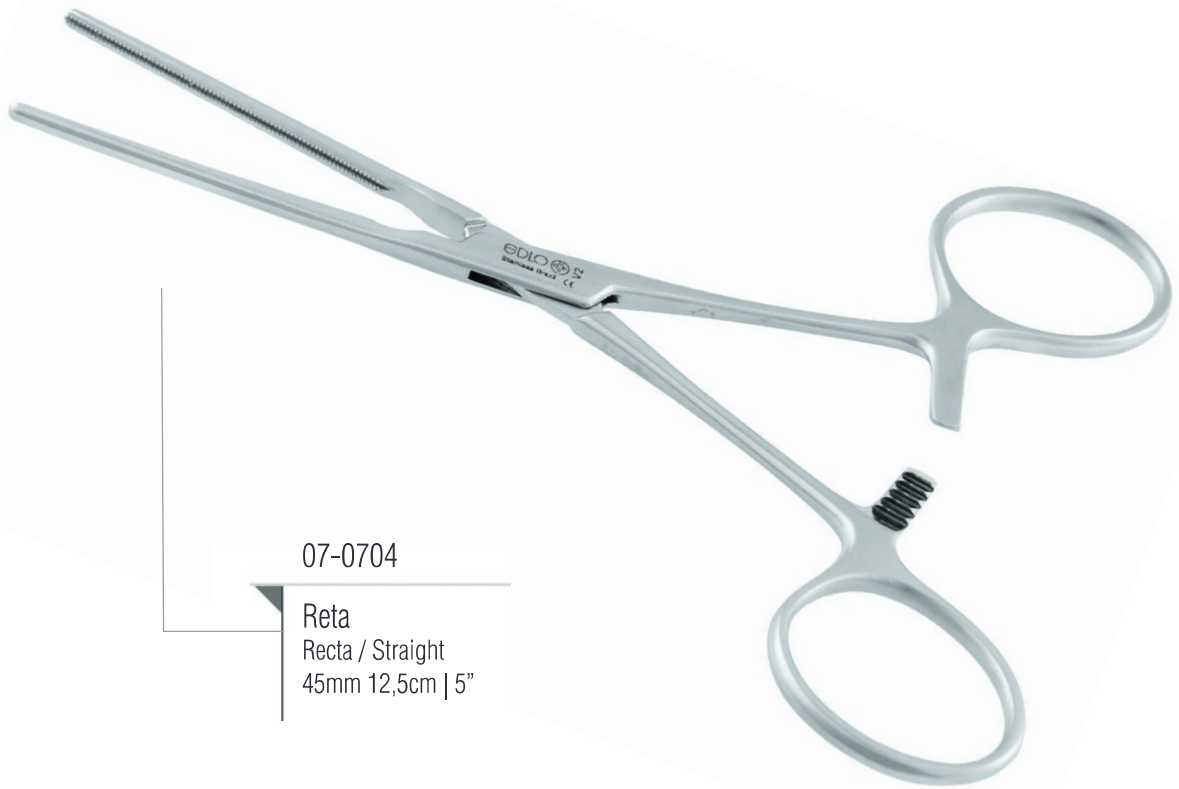

07-0704

Reta
Recta / Straight
45mm 12,5cm | 5"



07-0550

Reta
Recta / Straight
40mm 15,5cm | 6 1/2"



07-3032

Reta
Recta / Straight
65mm 18cm | 7"

De Bakey

07-0554

45° 12,5cm | 5"

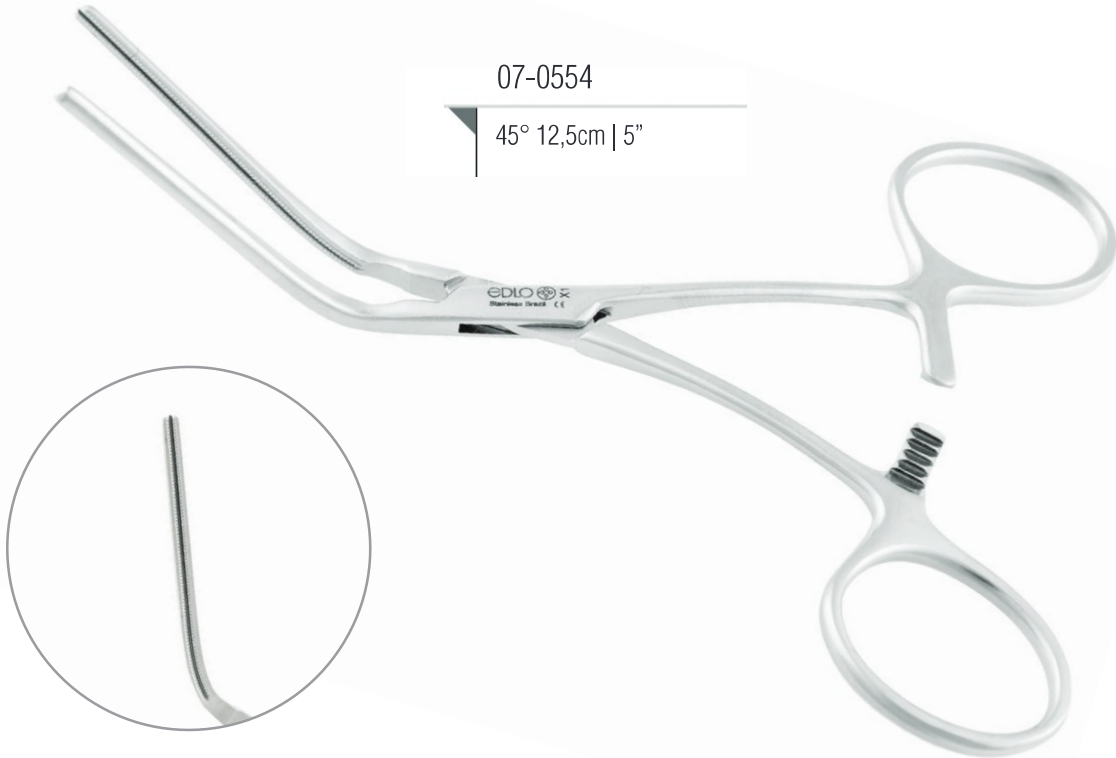

07-0702

40mm 90° 10,5cm | 4 1/4"



De Bakey Potts

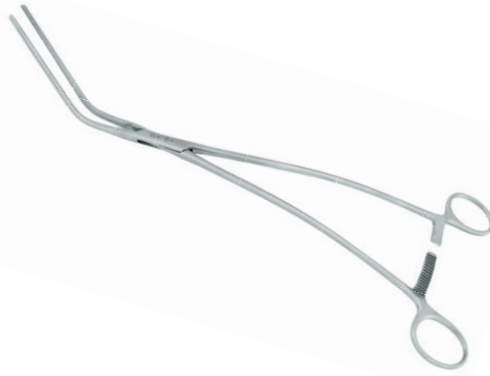

07-0712

Angulada
Angular / Angled
21cm | 8 1/4"



07-0709

Curva
Curva / Curved
22cm | 8 3/4"



07-0710

Angulada
Angular / Angled
22cm | 8 3/4"

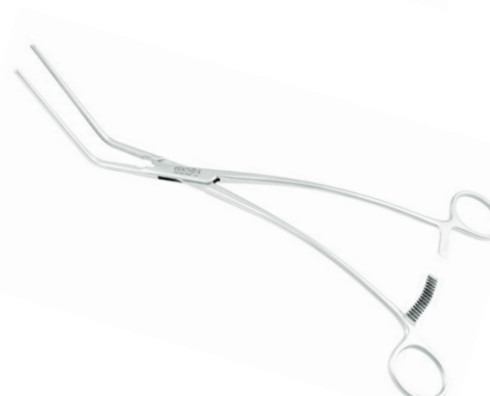

07-0721

Curva
Curva / Curved
21cm | 8 1/4"

De Bakey Potts

07-0711

Reta
Recta / Straight
21cm | 8 1/4"

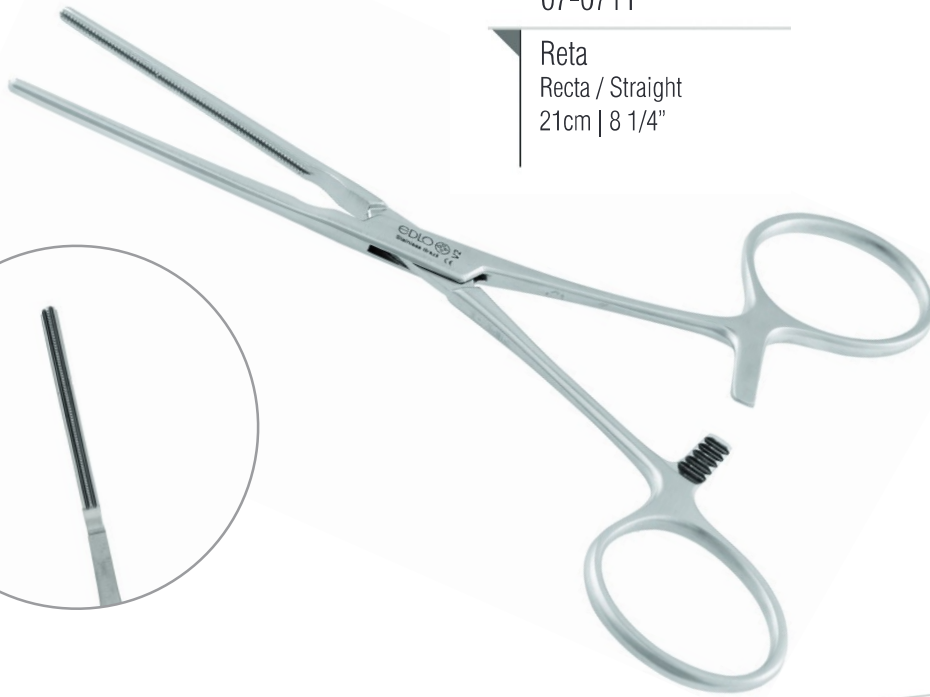

De Bakey-Beck

07-0798

17cm 6 3/4"

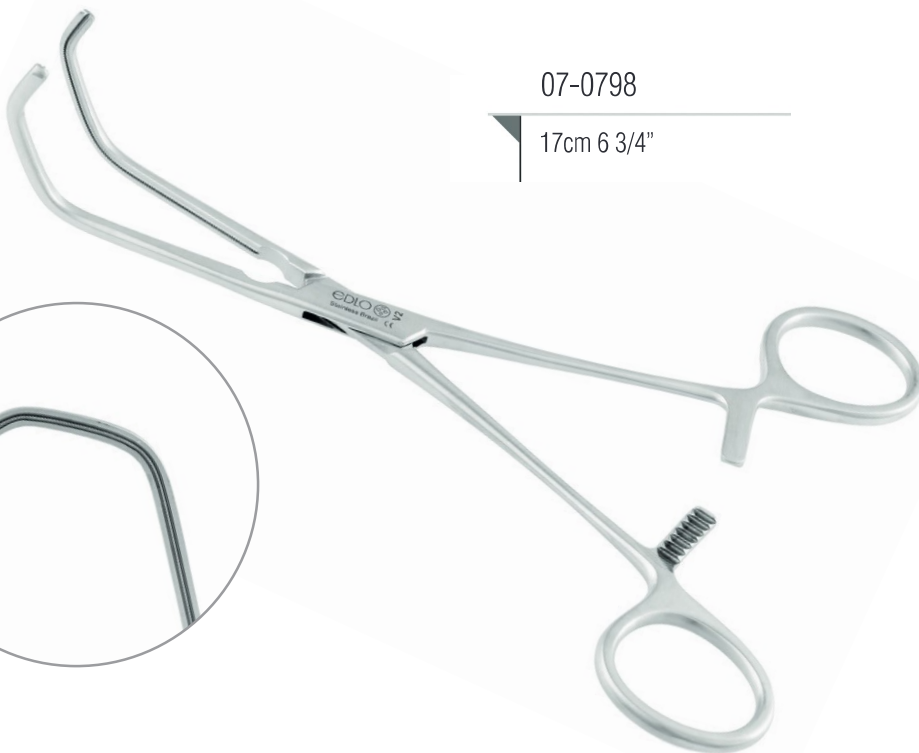

De Bakey-Glover



07-0540

Clamp de Anastomose Curvo
Anastomosis Clamp Curvo
Anastomosis Curved Clamp
50mm 17cm | 6 3/4"

Derra

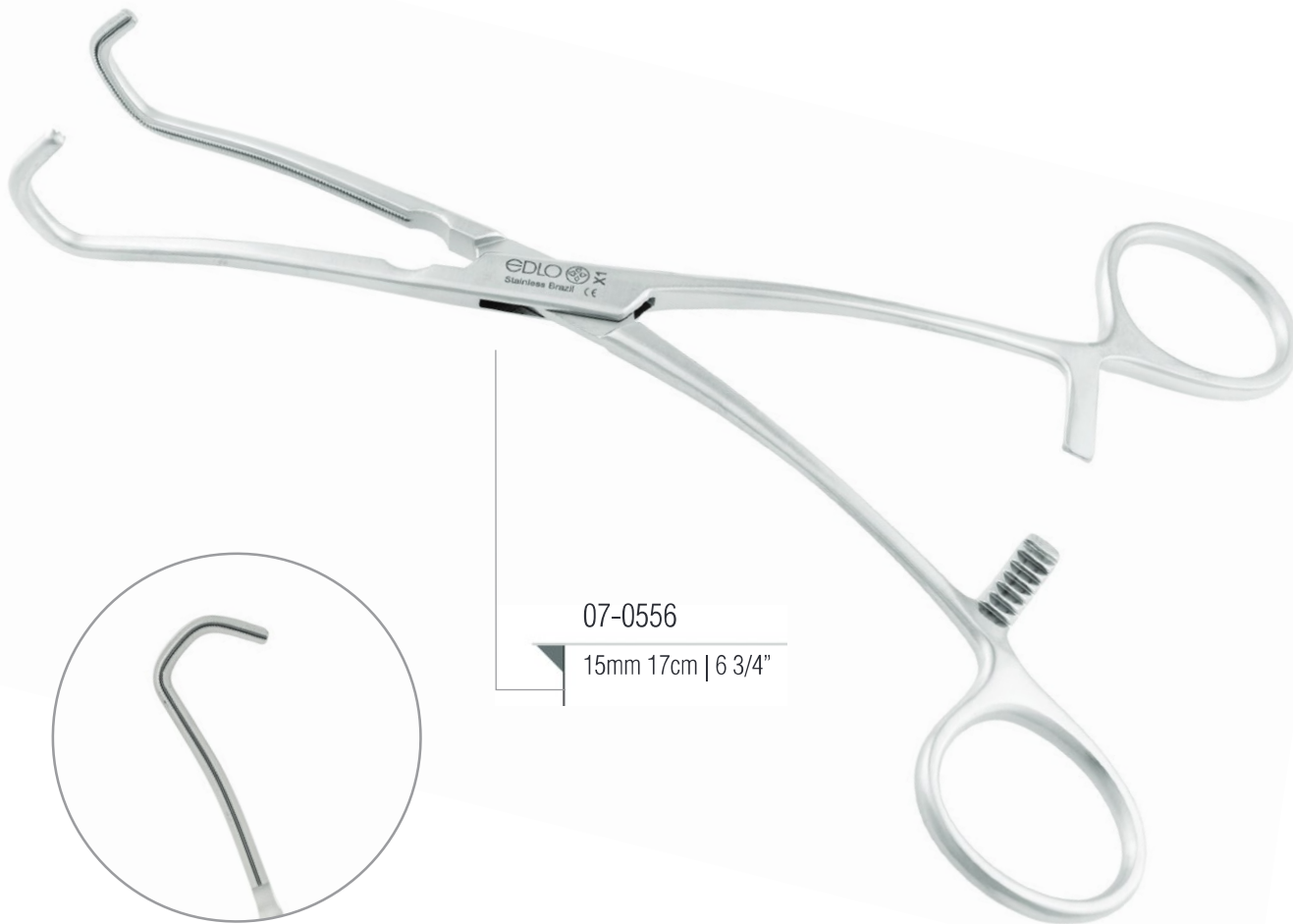

07-0556

15mm 17cm | 6 3/4"



07-0708

20mm 17cm | 6 3/4"



07-0557

25mm 17,5cm | 7"



07-2890

Forte
Fuerte / Strong
20mm Forte 17cm | 6 3/4"

Lambert-Kay

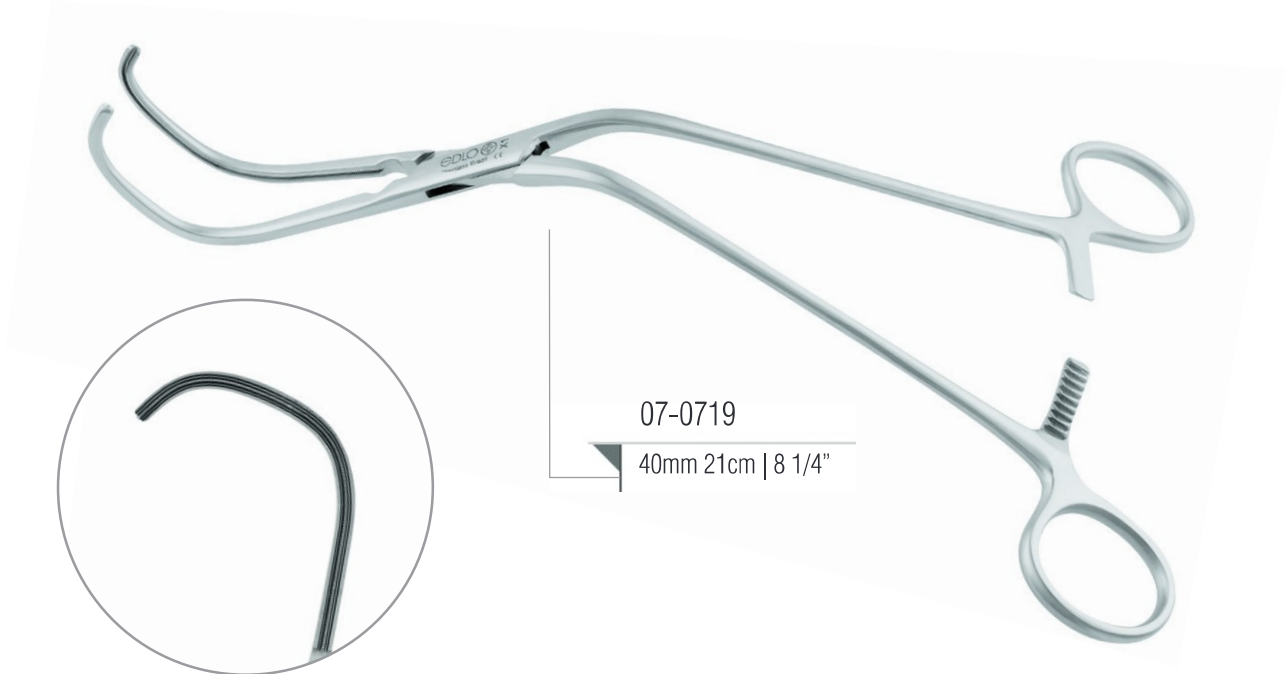

Leland-Jones

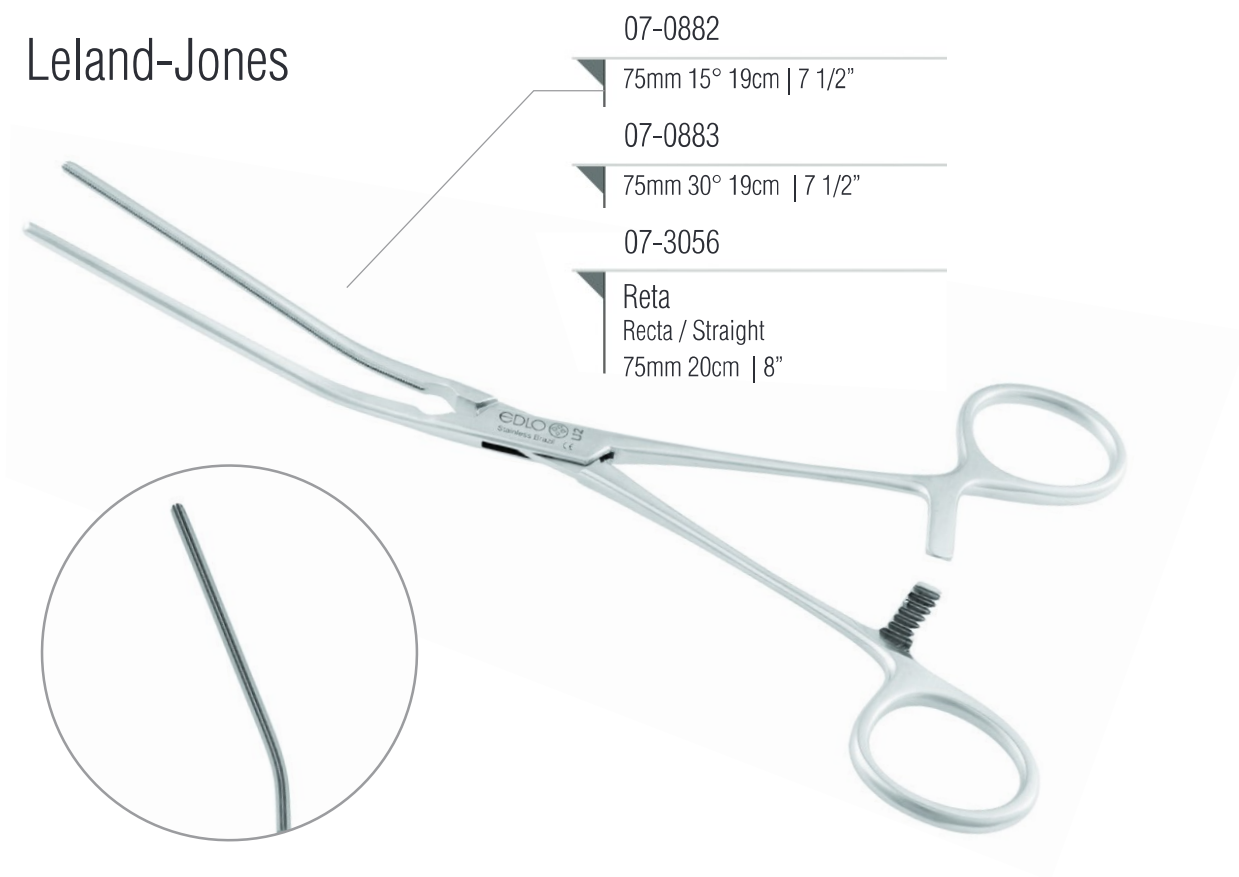

Ordenha

03-2610

14cm | 5 1/2"



03-2602

21,5cm | 8 1/2"



Saca Cálcio

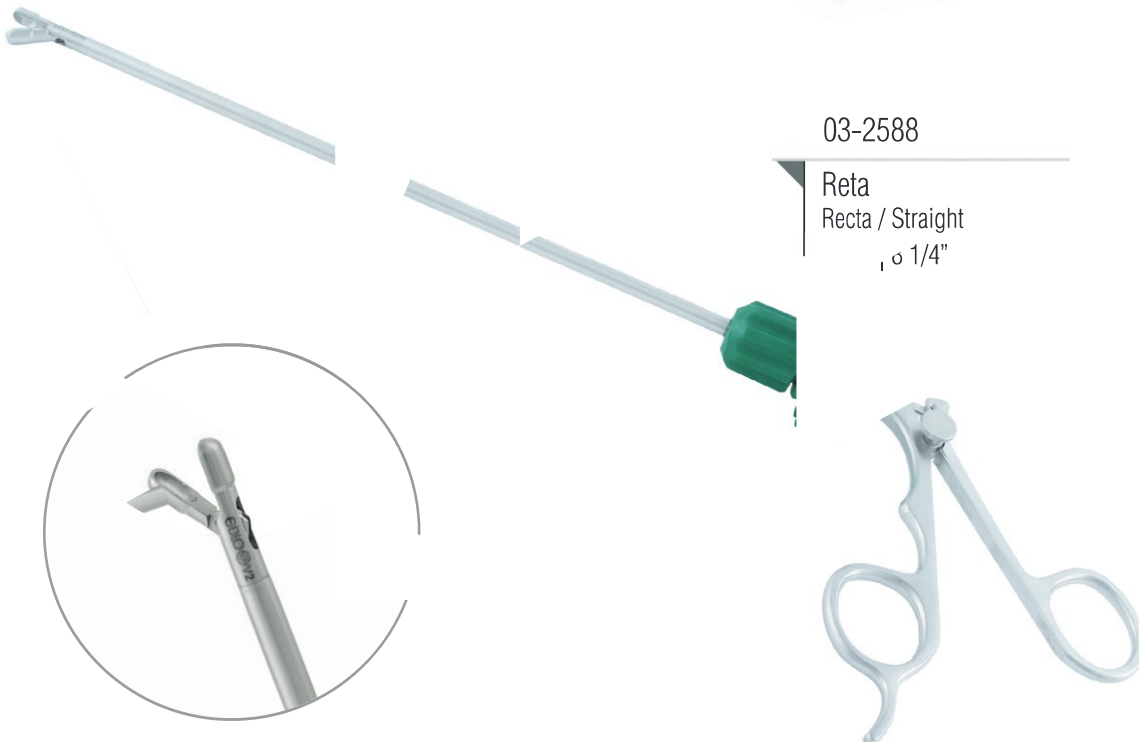
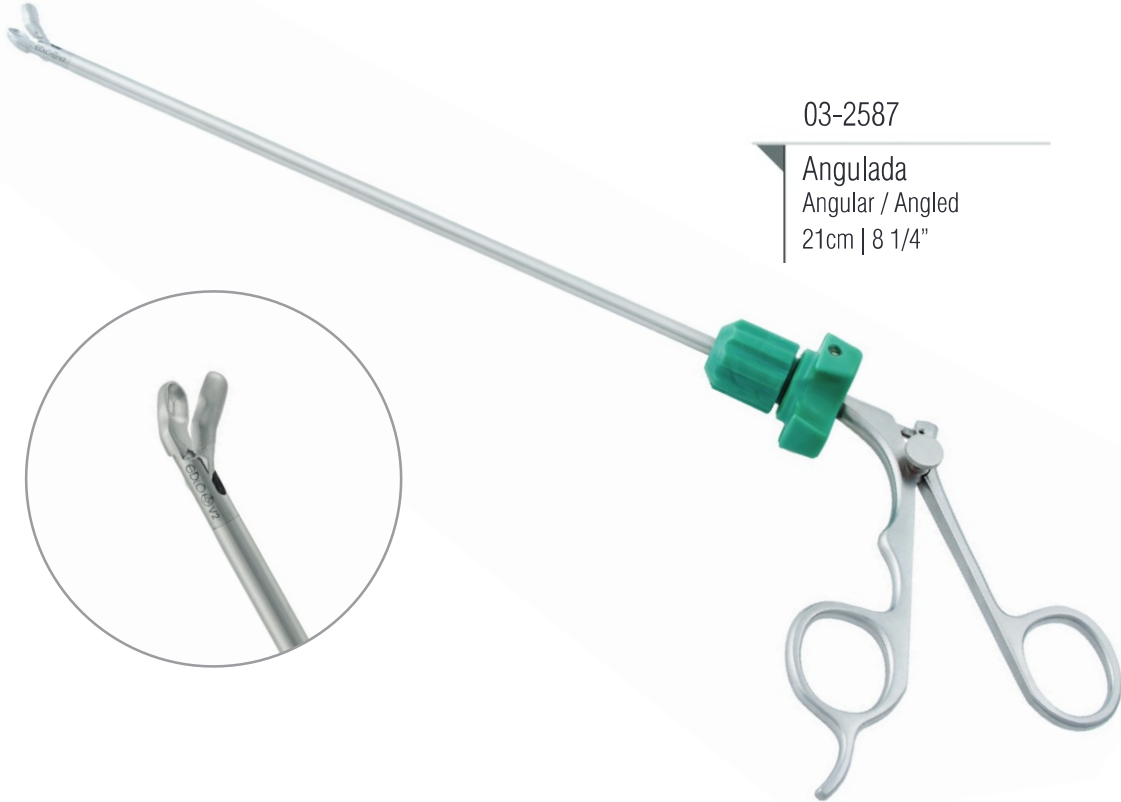

Pinça para Válvula Mitral

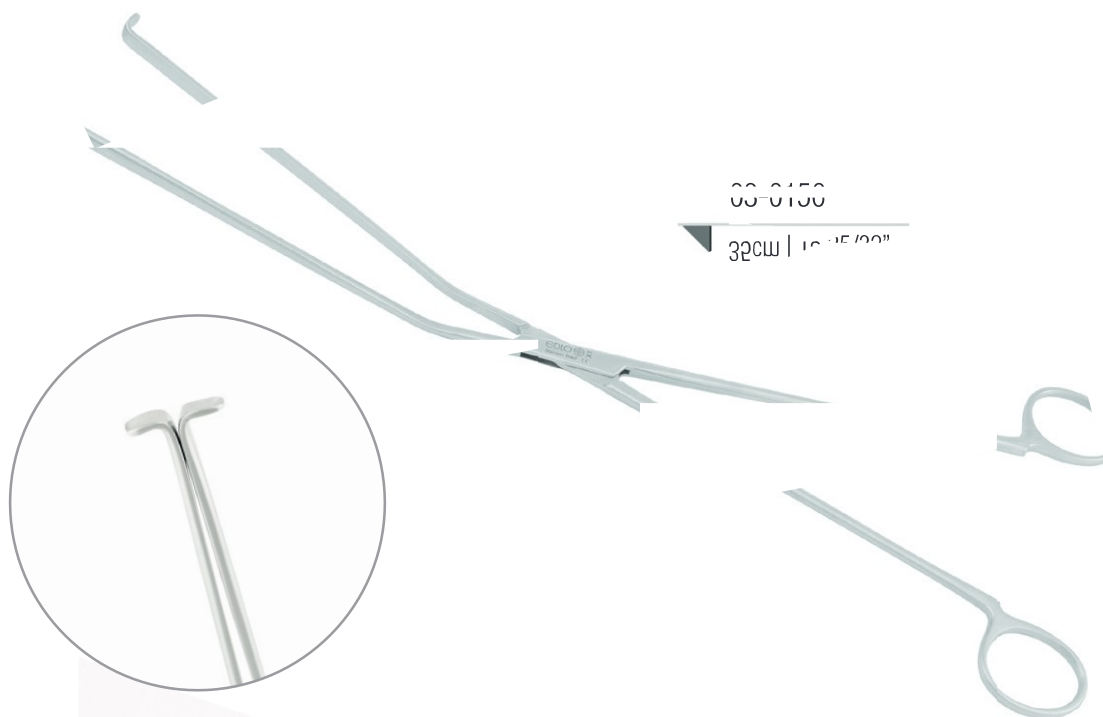
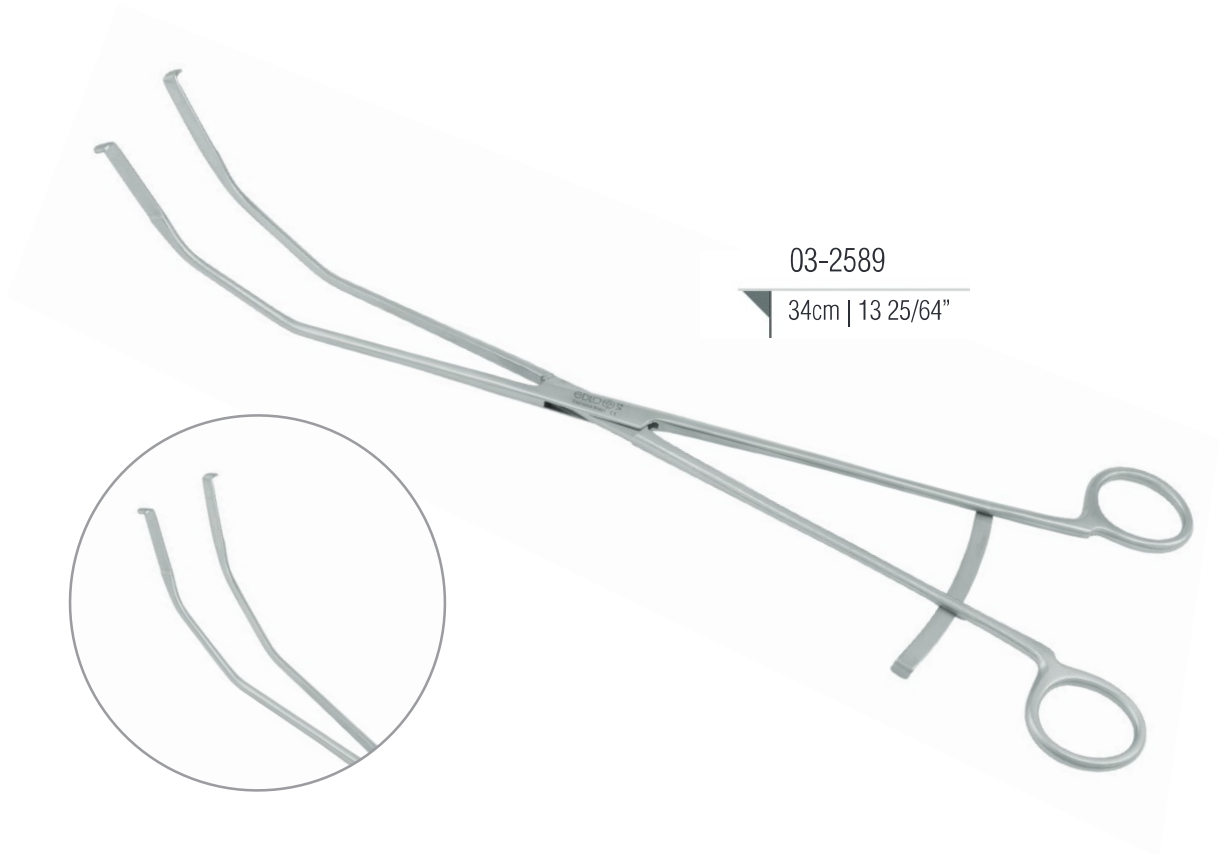

Satinsky

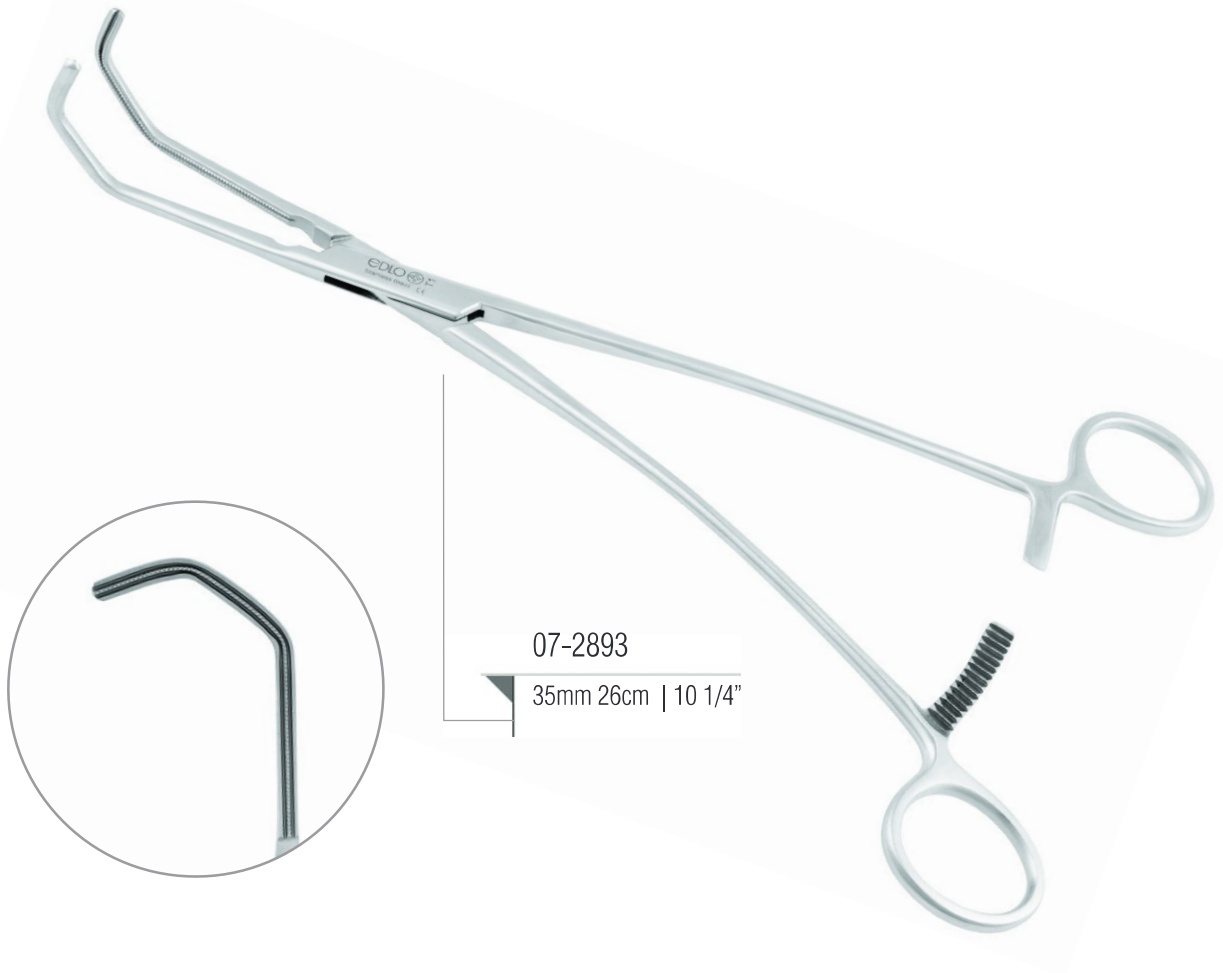

07-2893

35mm 26cm | 10 1/4"



07-0705

45mm 26cm | 10 1/4"



07-0548

55mm 26cm | 10 1/4"



07-0706

60mm 27,5cm | 11"



07-0707

75mm 28cm | 11"

Lahey



03-0221

Curva
Curvo / Curved
19cm | 7 1/2"

03-0222

Curva
Curvo / Curved
23cm | 9"



Lower



03-0223

19cm | 7 1/2"



Semb



03-0571

Curva
Curvo / Curved
24cm | 9 1/2"

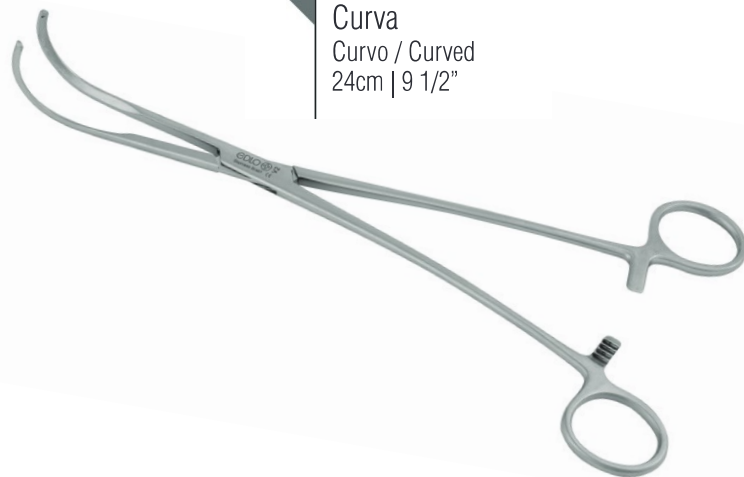

Carótida

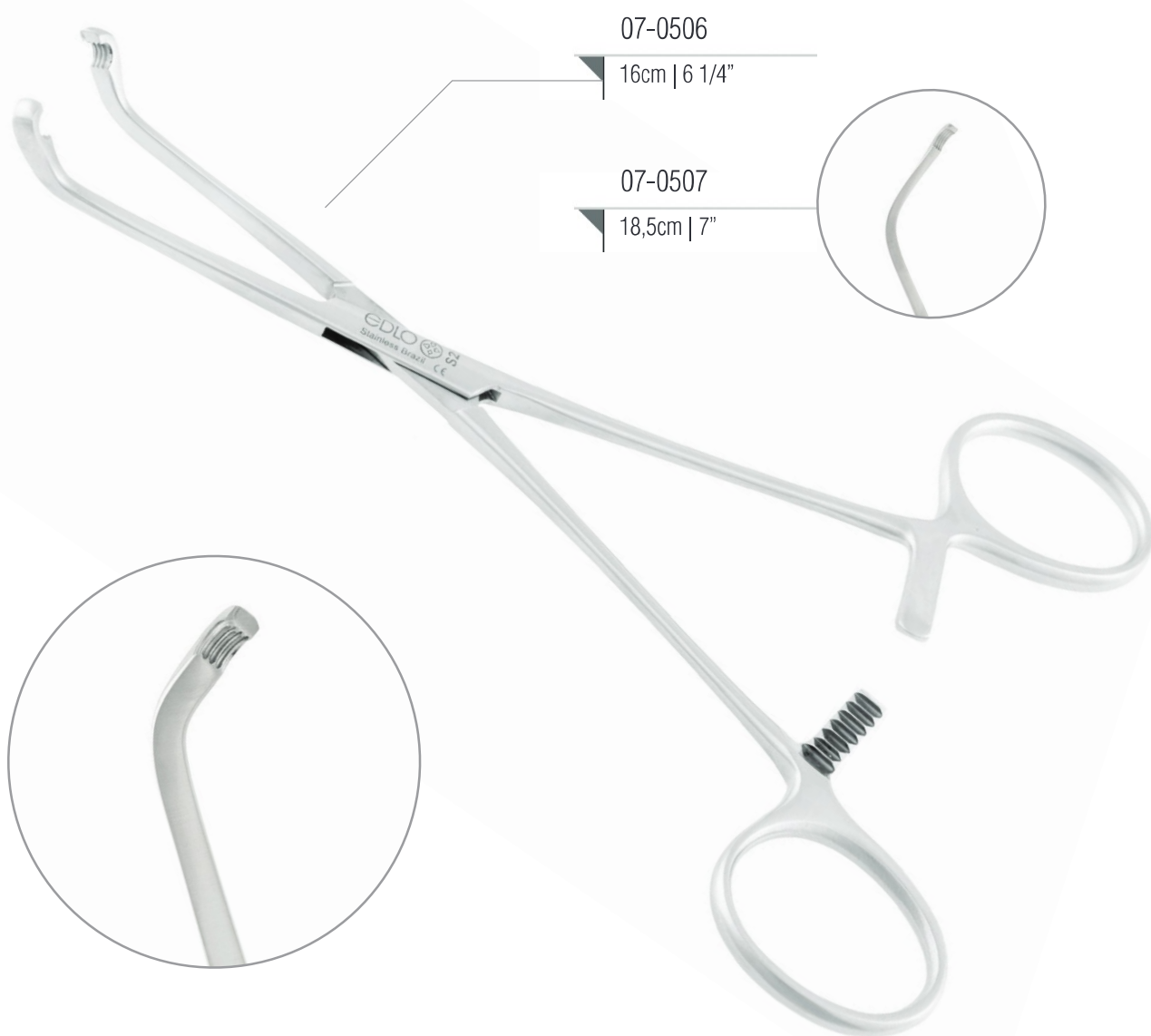

Denis



04-0486

20cm | 8"

Dietrich

Reta
Recta / Straight

07-0697

15cm | 6"

07-0698

20cm | 8"

07-0699

24cm | 9 1/2"

07-2894

18cm | 7"

07-2895

22cm | 8 3/4"

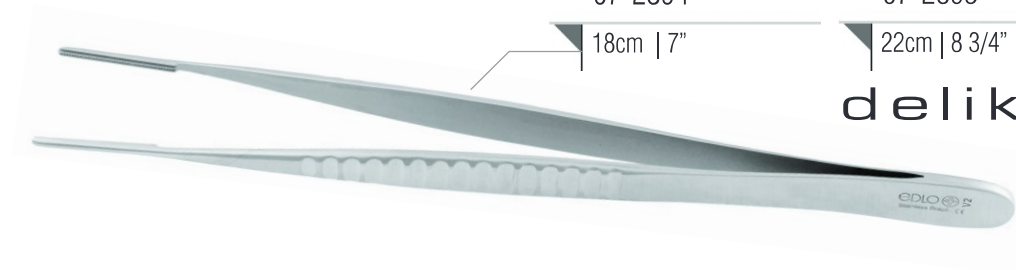

delikat

Dinkhuysen



04-2705

24cm | 9 1/2"

Punch Aórtico

07-0487

4.0mm 17cm | 6 3/4"

07-0489

5.5mm 17cm | 6 3/4"

07-2994

3.5mm 17cm | 6 3/4"

07-0488

4.5mm 17cm | 6 3/4"

07-0490

5.0mm 17cm | 6 3/4"

07-2995

3.0mm 17cm | 6 3/4"



Boyd

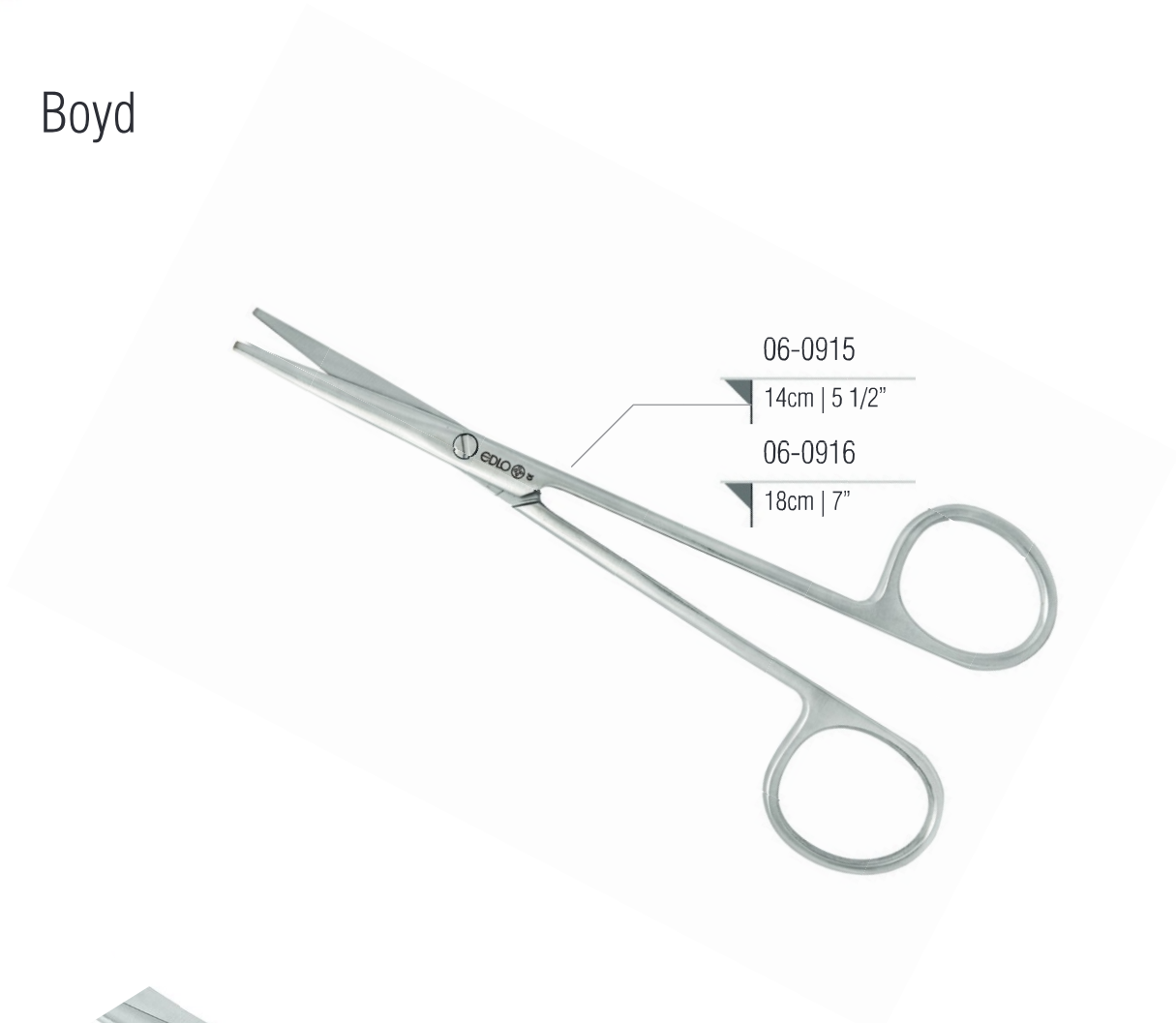

06-0915

14cm | 5 1/2"

06-0916

18cm | 7"

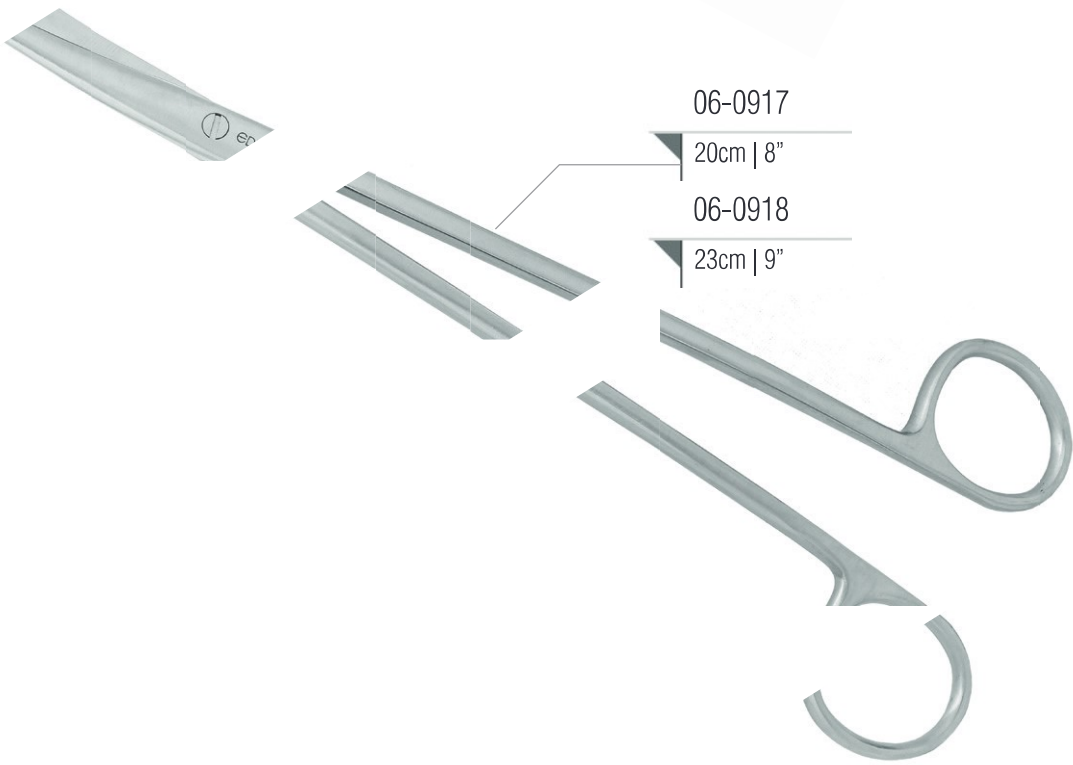

06-0917

20cm | 8"

06-0918

23cm | 9"

Boyd

06-0936

14cm | 5 1/2"

06-0937

18cm | 7"

Duracorte®



06-0938

20cm | 8"

06-0939

23cm | 9"

Duracorte®

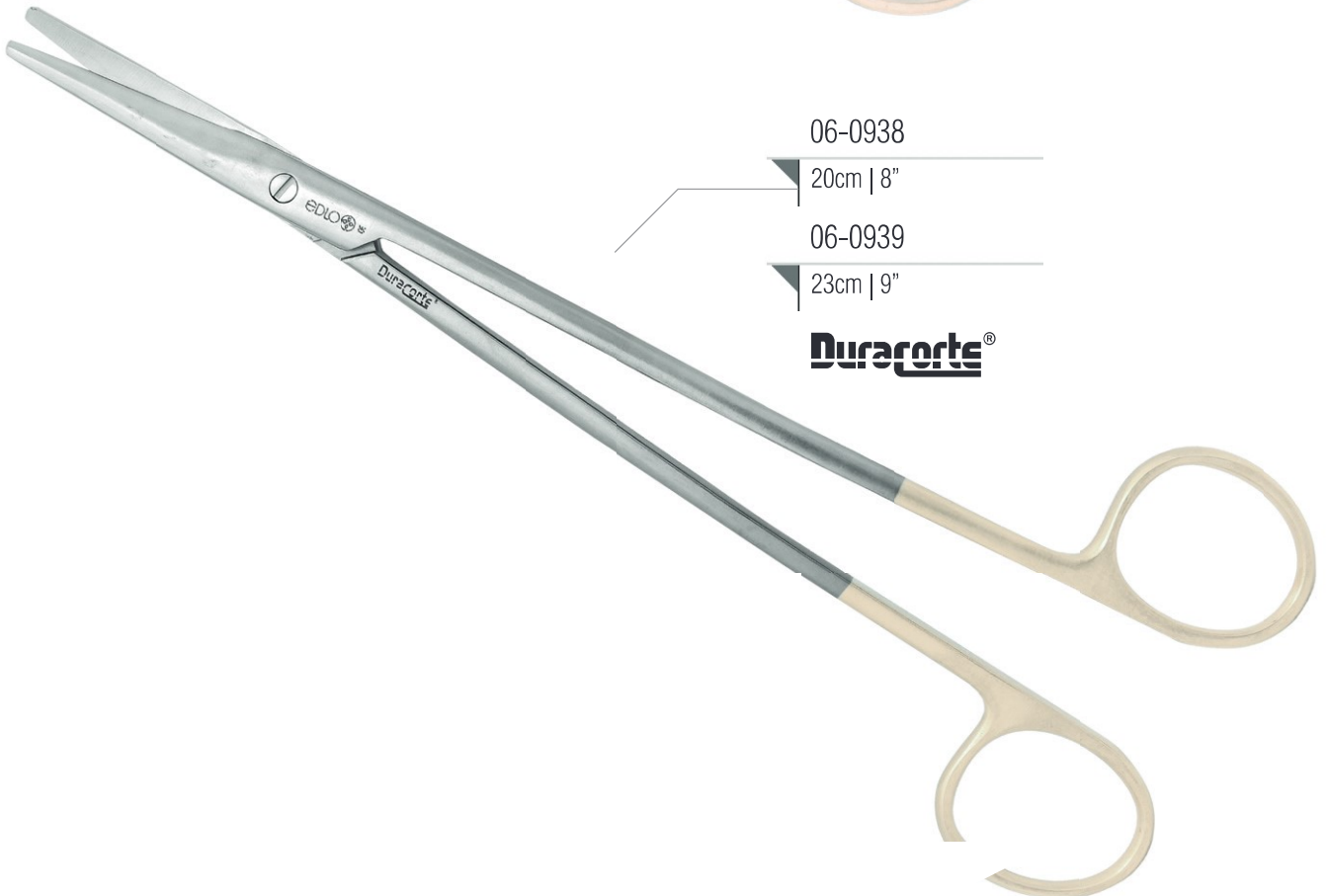

Dietrich



06-0787

25° 18,5cm | 7 1/4"

06-0788

45° 18cm | 7"

Dietrich

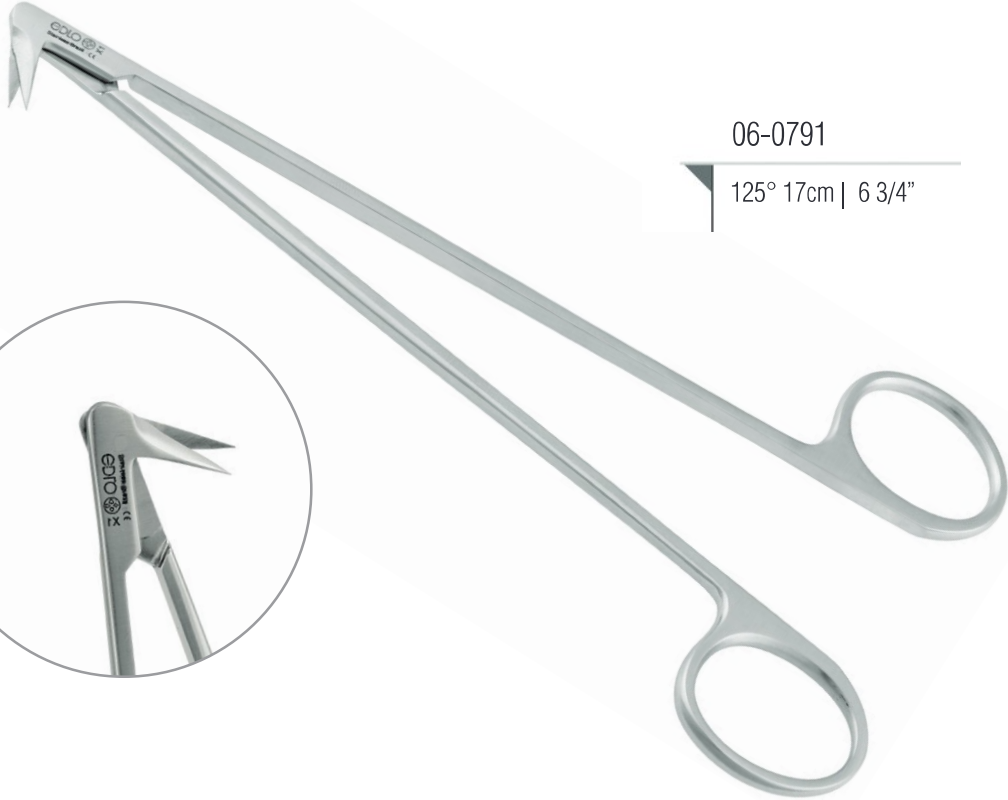

06-0791

125° 17cm | 6 3/4"



06-0790

90° 17cm | 6 3/4"



06-0789

60° 17,5cm | 7"

Dietrich

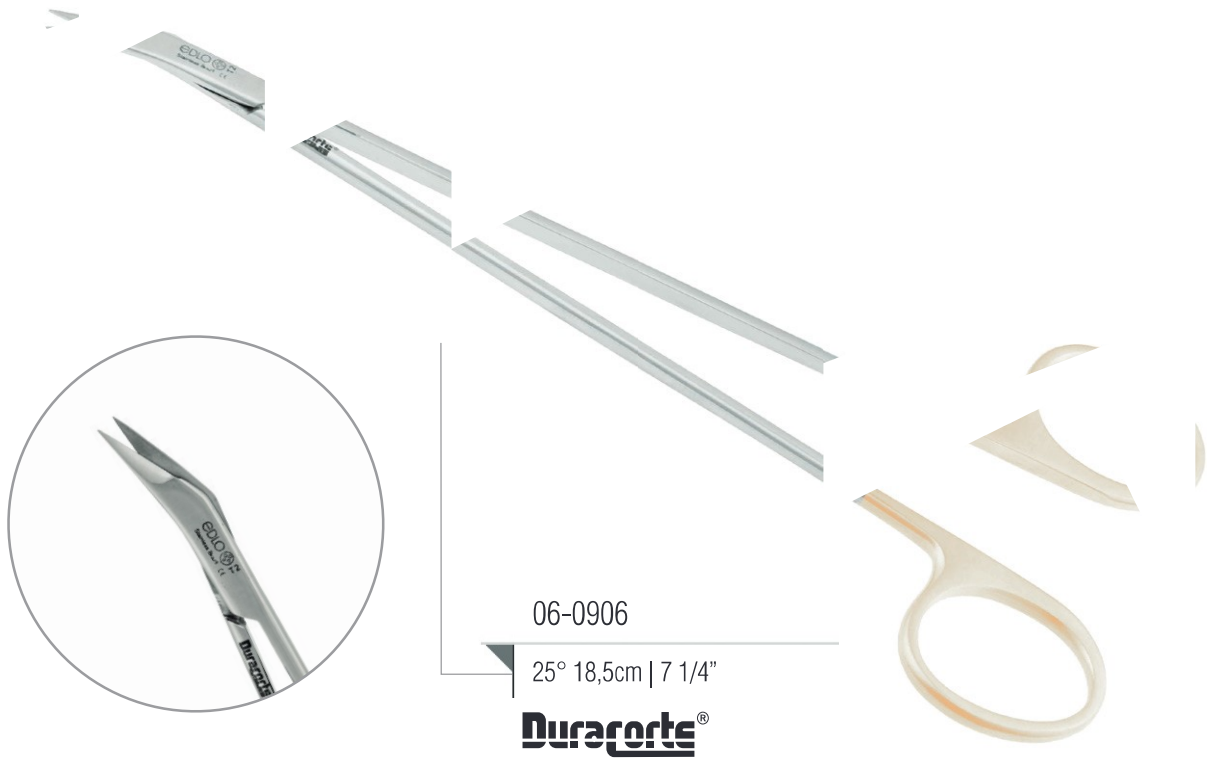

06-0906

25° 18,5cm | 7 1/4"

Duracorte®



06-0907

45° 18cm | 7"

Duracorte®



06-0908

60° 17,5cm | 7"

Duracorte®



06-0909

90° 17cm | 6 3/4"

Duracorte®



06-0910

125°, 17cm | 6 3/4"

Duracorte®

Potts de Martel

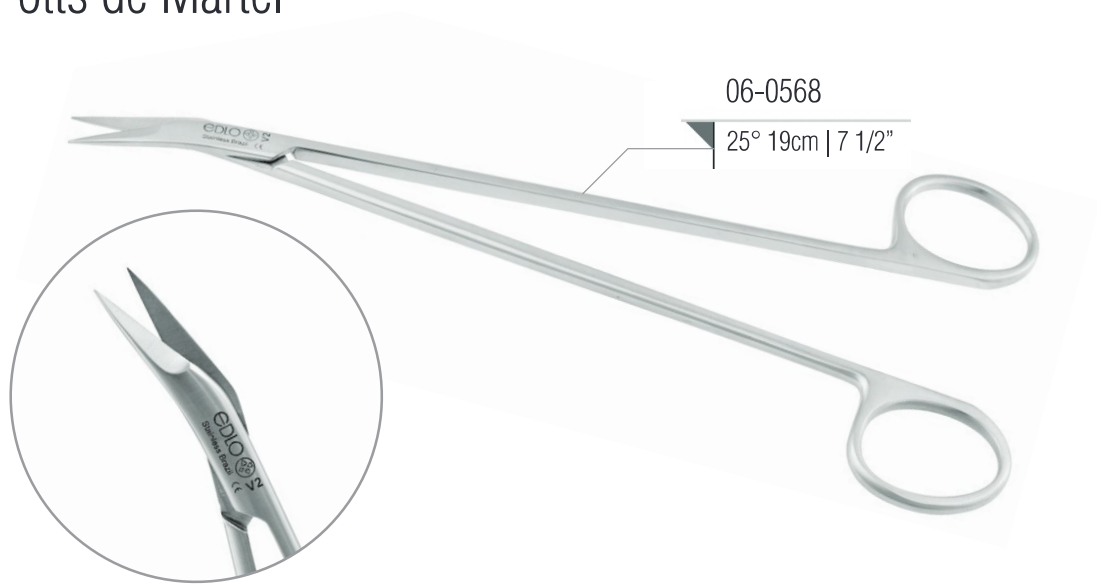

06-0568
25° 19cm | 7 1/2"



06-0569
40° 19cm | 7 1/2"



06-0570
60° 19cm | 7 1/2"



06-0648
25° 19cm | 7 1/2"
Duracorte®



06-0652
40° 19cm | 7 1/2"
Duracorte®



06-0653
60° 19cm | 7 1/2"
Duracorte®

Metzenbaum Cárdio

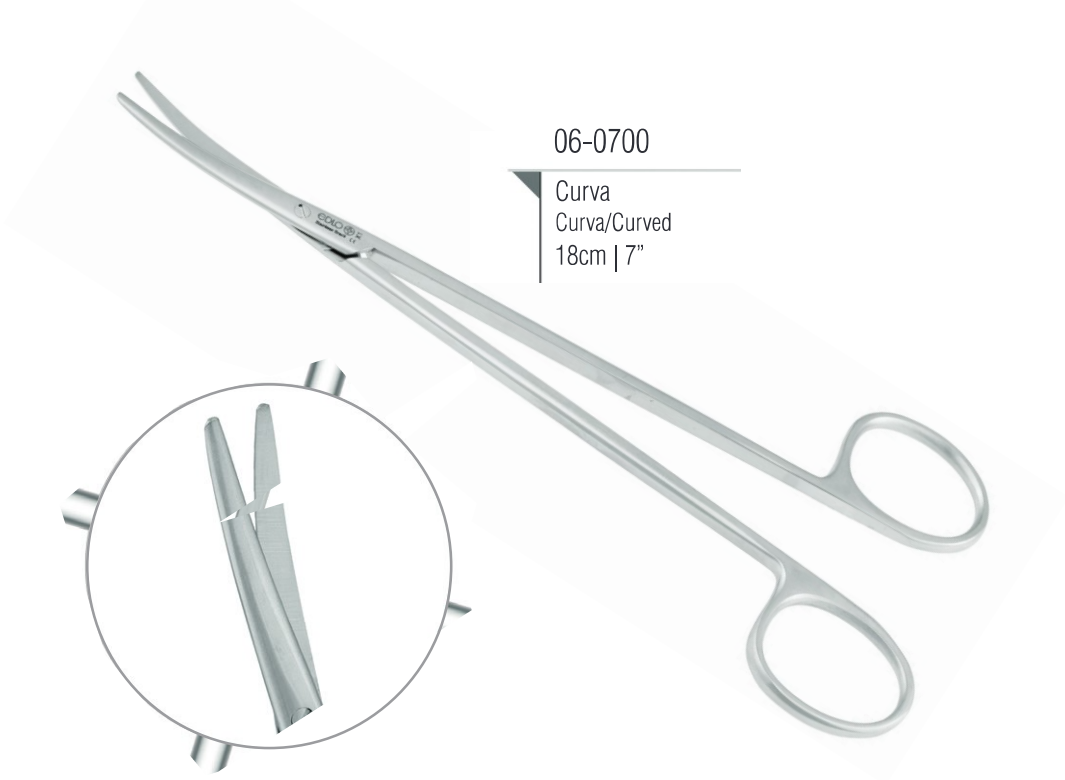

06-0700

Curva
Curva/Curved
18cm | 7"

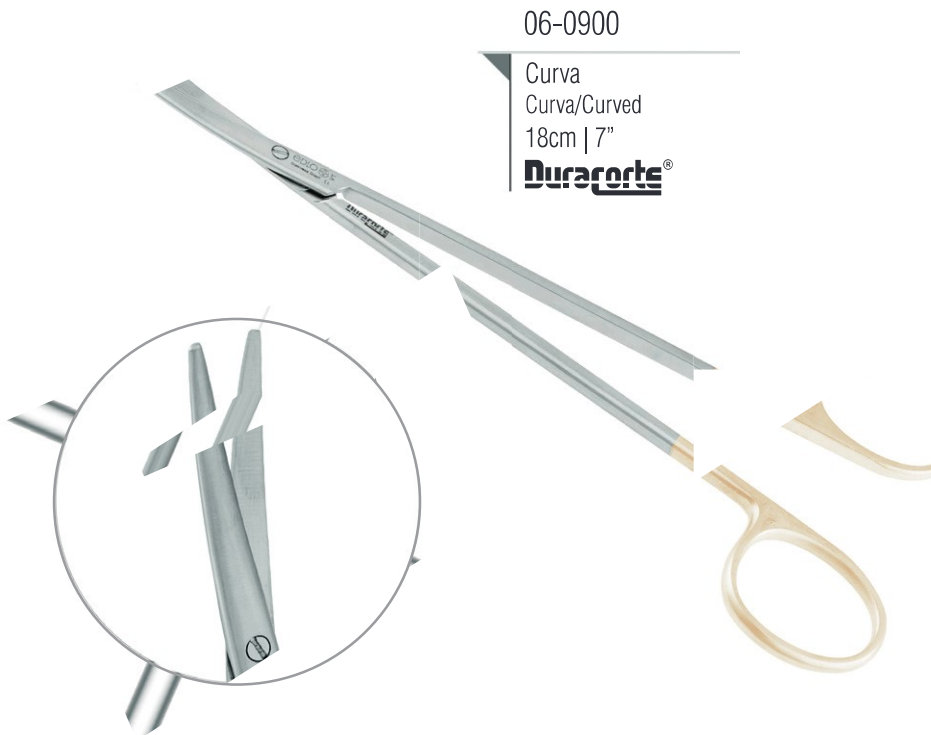
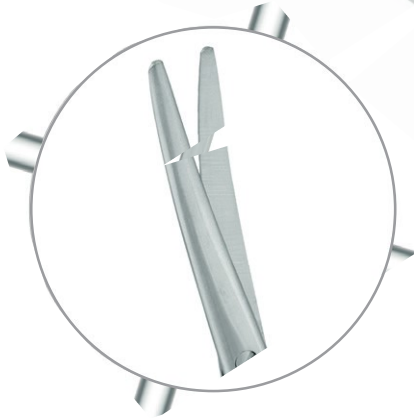

06-0900

Curva
Curva/Curved
18cm | 7"

Duracorte®

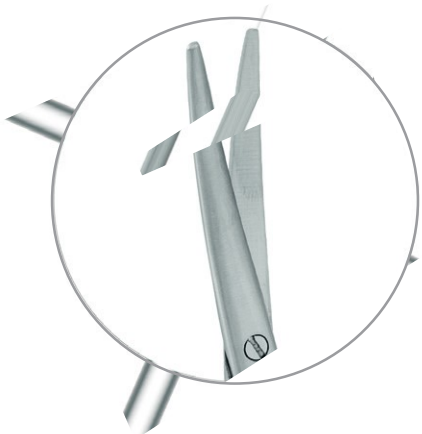

De Bakey



10-0777

1,0mm 20cm | 8"

10-0778

1,5mm 20cm | 8"



10-0779

2,0mm 20cm
8"



10-0780

2,5mm 20cm
8"



10-0781

3,0mm 20cm
8"



10-0783

4,0mm 20cm
8"



10-0784

4,5mm 20cm
8"



10-0785

5,0mm 20cm
8"



10-0782

3,5mm 20cm
8"

10-3406

0,5mm 19cm
7 1/2"

10-3407

7,0mm 19cm
7 1/2"

10-3408

9,0mm 19cm
7 1/2"

Porta agulhas para Coronária

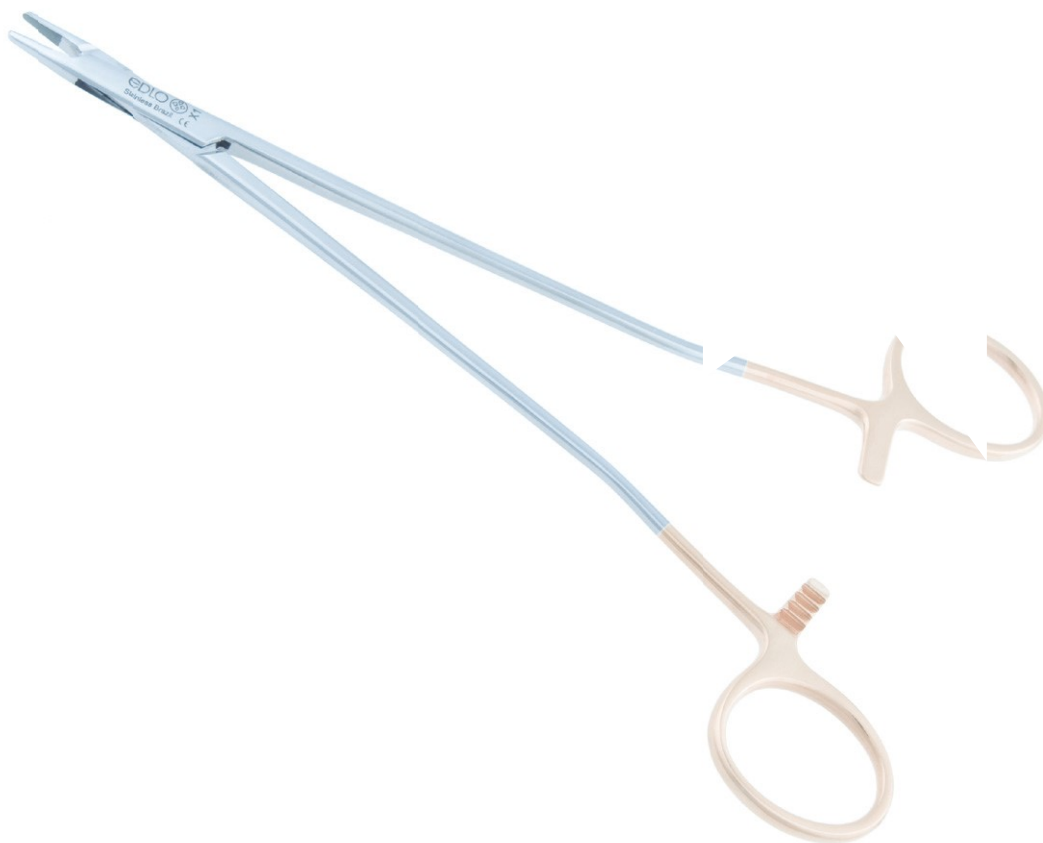

05-0929

C/ Vídia 17cm | 6 3/4"

HARDTIP®



05-0930

C/ Vídia 19cm | 7 1/2"

HARDTIP®



05-0931

C/ Vídia 22cm | 8 3/4"

HARDTIP®

Conjunto Flebo Extrator

10-3068





ITM Indústria de Tecnologias Médicas Ltda.

Rua Berto Círio, 751
Canoas - RS - Brasil - Cep 92420-030
Fone: +55 51 3052.3900

www.edlo.com.br

Siga-nos nas Redes Sociais:

 /edloitm

 @edloitm

 /edloitm

